

Build IC/VAMP Receiver—tunes 80-1700 kHz

AUGUST-SEPTEMBER 75c

Science and Electronics

**WHITE'S
RADIO
LOG**

- FM Stations
- Worldwide Shortwave
- Police/Emergency

PROTECT

your loved ones, property, valuables and neighbors with our

SAFETY SIREN

a mini-project everyone should build and own!



DISCOVER

the exciting world of static electricity with

ELECTRO-SNOOP

the charge detector that tells you if it's there and what polarity!



SPECIAL CONSTRUCTION ISSUE

ILLUMINATE

for safety with our marker beacon/signal light

GOLD FLASH

that marks trails, road turnoffs, dock space for more than a year!



Dazzle your friends with lightworks.



Sound n' Color®

The new dimension to music pleasure. EICO All Electronic Solid-State Audio-Color Organs transform sound waves into moving, synchronized color images. Connect easily to speaker leads of hi-fi or radio. From \$29.95.



Translators

The electronics you need to create audio-stimulated light displays to your own imagination. Actuates Light Display Units, Strobe Lites, any lamp configuration (Xmas trees, patio lights, etc.). From \$24.95 kit, \$39.95 wired.



Strobe Lites

High-intensity bursts of white light from Xenon tube flash in cadence with each beat of audio. From \$24.95 kit, \$39.95 wired.

Build the Stereo Kits praised by experts.

All amplifier power ratings according to IHF standards. Cortina® designed and manufactured in U.S.A. and guaranteed by EICO.



70-Watt AM/FM Stereo Receiver including cabinet. Cortina 3770. \$189.95 kit, \$279.95 wired.



150-Watt Silicon Solid-State Stereo Amplifier including cabinet. For the audio perfectionist. Cortina 3150. \$149.95 kit, \$225 wired.

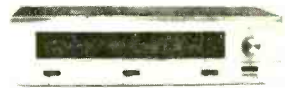

FM Stereo Tuner including cabinet. Cortina 3200. \$99.95 kit, \$139.95 wired.

70-Watt FM Stereo Receiver including cabinet. Cortina 3570. \$169.95 kit, \$259.95 wired.

70-Watt Silicon Solid-State Stereo Amplifier including cabinet. Cortina 3070. \$99.95 kit, \$139.95 wired.



EC-1100
FM WIRELESS MIKE \$9.95

Build for fun and use with Eicocraft jiffy project kits.

The newest excitement in kits. 100% solid-state and professional. Expandable, interconnectable. Excellent as introductions to electronics. No technical experience needed. Finest parts, pre-drilled etched printed circuit boards, step-by-step instructions. 26 kits to select from. \$2.50 to \$9.95. Just released: EC-2600 "Super Snoop" \$8.95. EC-2700 Police & Fire Converter



(to band) \$7.95; EC-2600 Aircraft Converter \$7.95; EC-2700 Police & Fire Converter (to band) \$7.95; EC-3100 2-Station Intercom (with cases) \$10.95; EC-3200 "Do-It-Yourself" PC Etching Kit \$4.95; EC-2300 Audio Preamplifier \$8.95; EC-2400 Bullhorn \$8.95; EC-2500 Fuzzbox \$8.95.



EC-1900 TREASURE FINDER \$9.95

Shape up your own car/boat with EICO Engine Analyzer

For all 6V/12V systems; 4, 6, 8-cyl. engines. Now you can keep your car or boat engine in tip-top shape with this solid-state, portable, self-powered universal engine analyzer.

Completely tests your total ignition/electrical system. Complete with comprehensive Tune-up & Trouble-shooting Manual. EICO 888, \$49.95 kit, \$69.95 wired.

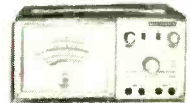

The first and only solid state test equipment GUARANTEED FOR 5 YEARS

Only EICO brings you laboratory precision and long life at lowest cost.



EICO 240 Solid-State FET-TVOM \$59.95 kit, \$79.95 wired



EICO 379 Solid-State Sine Square Wave Generator \$69.95 kit, \$94.50 wired

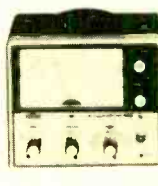

EICO 242 Solid-State Deluxe FET-TVOM \$69.95 kit, \$94.50 wired



EICO 150 Solid-State Signal Tracer \$49.95 kit, \$69.95 wired



EICO 330 Solid-State RF Signal Generator \$59.95 kit, \$84.50 wired

You save up to 50% with EICO Kits. Since 1945. Best Buys in Electronics. Over 3 Million EICO Instruments Now in Use.

FREE 1970 CATALOG

Send me FREE catalog describing the full EICO line of 200 best buys, and name of nearest dealer.

SE-8



EICO Electronic Instrument Co., Inc.
283 Malta Street, Brooklyn, N.Y. 11207
EICO Canada Ltd.
20 Millwick Drive, Weston, Ontario

Name _____

Address _____

City _____

State _____

Zip _____

Make this page the real turning point in your life

If you're looking for that one big chance to make good, you've just taken a turn for the best.
Here is your opportunity checklist.
It helps you select the program of home study that will mean the most to your future.
Choose from one of the 266 ICS Courses. Or find out how ICS can tailor a course to fit your special needs.
Consider this: one out of every fourteen presidents of today's top companies studied with ICS.
For them, ICS was a turning point. It can be for you, too! Get started by mailing the coupon — today!

LEADERS IN THE ICS SUCCESS PARADE . . .
Automobile Engine Tune-Up
Introduction to the IBM System/360 Computer
Business Accounting
Civil Engineering
Practical Electricity
Radio-TV Servicing
Architectural Drafting
High School Courses
High School Equivalency
Reading Air Conditioning
Aircraft and Power Plant Mechanics

Fundamentals of House Planning and Interior Design
Mason, Framing Contractor
Review in Architectural Design and Practice
Review of Mechanical Systems in Buildings
ART
Artist
Commercial Art
General Accounting
Income Tax (U.S.A.)
Industrial Accounting
Office Accounting
Practical Accounting
Public Accounting
Small Business (U.S.A.)
Starting and Managing a Service Business (U.S.A.)
ARCHITECTURE AND BUILDING
Architectural Drawing and Designing
Architecture
Building Contractor
Building Inspector
Building Maintenance
Building Mechanic
Carpenter-Builder
Carpentry and Millwork
Automobile Body
Automobile Body Refinishing
Automobile Mechanic
Automobile Technician
Diesel-Gas Motor Vehicle Engines

BUSINESS
Advertising
Business Administration
Business Practice (Cont.)
Design & Operation
Direct Mail and Mail Order
Advertising
Industrial Psychology
Inventory & Newspaper
Managing a Retail Business
Managing a Small Store
Marketing Research
Modern Etc. Management
Office Automation
Office Management
Purchasing Agent
Retail & Local Advertising
Retail Buying
Retail Selling
Retail Sales Procedures
Systems and Procedures
Analysis
BUSINESS: SALES
Creative Salesmanship
Real Estate Salesmanship
Sales Management
BUSINESS: SUPERVISION
Basic Supervision
Industrial Supervision
Management, Salesmanship
Modern Woman as a Supervisor
Personality Development
Supervision
Supervision in Labor Relations
CHEMICAL
Chemical Analyst

Chemical Engineering
Chemical Laboratory Techn.
Chemical Process Equip.
Design & Operation
Elements of Nuclear Energy
General Chemistry
Instrumental Laboratory
Analysis
CIVIL ENGINEERING
Construction Eng'g Tech.
Highway Engineering Tech.
Principles of Surveying
Reading Highway Blue Prints
Sanitary Engineering Tech.
Sewage Plant Operator
Structural Eng'g Tech.
Water Works Operator
COLLEGE COURSES
American Economics
Calculus
COMPUTERS
COBOL Programming for Fortran
Programming for Digital Computers
Programming the IBM System/360 Computer
Introduction
DRAFTING
Architectural Drafting
Civil Engineering
Drafting Technology
Electrical Drafting
Electronic Drafting
Introductory Mech. Drafting
Pressure-Vessel and Tank
Print Reading

Sheet Metal Layout for Air Conditioning
Structural Drafting
ELECTRICAL
Electrical Engineering
—Electronics Option
Power Option
Electrical Appliances
with Equipment Training
Electrical Contractor
Electrical Home Maint.
Electrical Home Wiring
with Equipment Training
Electrical Instrument Tech.
Industrial Electrical
Power-Line Design
Power-Line Operator
—Hydro Option
—Steam Option
Practical Electrician with Equipment Training
Practical Lineman
Reading Etc. Blueprints
ENGINEERING (Refreshers Courses for Graduate Engineers)
Chemical
Civil
Electrical
Industrial
Mechanical
Sanitary
ENGLISH AND WRITING
Better Business Writing
College English
Composition and Rhetoric
English for Spanish (U.S.A.)
Free Lance Writing for (U.S.A.)
Fun and Profit
Modern Letter Writing
Practical English

Reading Improvement
Short Story Writing
HIGH SCHOOL
High School Business
High School (Canadian)
High School General
High School Secretarial
High School Vocational
High School College
High School College Prep—Engineering and Science
Preparatory Course for High School Equivalency Test
MACHINE SHOP
Chemical Metallurgy
Industrial Metallurgy
Lathe Operator
Machine Shop Inspection
Multicraft Maintenance
Mechanical Millwrighting
Rigging, Ship Prints
Tool & Die Making
Tool & Engineering Tech.
Welding Processing Tech.
MATHEMATICS
Advanced Mathematics
Math and Mechanics for Engineering Technicians
High and Physics for Engineers
Modern Elementary Statistics
MECHANICAL
Mechanical Engineering
Aircraft and Power Plant Mechanic
Hydraulic and Pneumatic
Industrial Engineering

Industrial Eng'g Tech.
Machine Design
Quality Control
Power Plant Engineering
Stationary Fireman
Stationary Steam Eng'g
TEXTILES
Dyeing and Spinning
Loom Fixing
Textile Designing
Textile Mill Superintendent
Textile Mill Supervision
TRAFFIC
Motor Traffic Management
Traffic Management
ELECTRONICS
Electronics Technician
Computers
General Electronics with Equipment Training
Hi-Fi Stereo and Sound
Industrial Electronics
Industrial Electronics Tech.
Numerical Control
Electronics & Maint.
Radio & TV Servicing with Equipment Training
Telephony
PULP AND PAPER
Paper Machine Operator
Paper Mill
SECRETARIAL
Commercial Clerk-Typist
Secretary, Engineering
Sec'y, Legal, Medical
Short-hand
Stenographic
Typewriting

STEAM, DIESEL POWER
Boiler Inspector
Industrial Building Eng'r
Power Plant Engineering
Stationary Fireman
Stationary Steam Eng'g
TEXTILES
Dyeing and Spinning
Loom Fixing
Textile Designing
Textile Mill Superintendent
Textile Mill Supervision
TRAFFIC
Motor Traffic Management
Traffic Management
ELECTRONICS
Electronics Technician
Computers
General Electronics with Equipment Training
Hi-Fi Stereo and Sound
Industrial Electronics
Industrial Electronics Tech.
Numerical Control
Electronics & Maint.
Radio & TV Servicing with Equipment Training
Telephony

APPROVED FOR VETERANS FUND TUITION REFUND
Accredited member, National Home Study Council.
Easy pay-as-you-learn plan.
Special rates to members U.S. Armed Forces.

ICS®
International Correspondence Schools
Division of Intext

TAKE YOUR FIRST STEP . . . MAIL THIS COUPON TODAY — ICS, SCRANTON, PA. 18515

I'm interested in a program of independent study. Send me, without cost, your booklet on the principles of success, sample text demonstrating famous ICS method, and your catalog for _____

Miss _____
Mrs. _____
Mr. _____

Address _____

City _____ State _____ Age _____

Occupation _____ Employed by _____ Working Hours _____ A.M. to _____ P.M.

R4884F

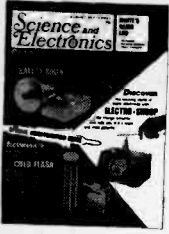

Science and Electronics

-
- ★ 25
- 39
-
- ★ 43
- ★ 47
- 75
-
- 30
- 31
- ★ 59
-
- 18
- 38
- 55
- 72
- 79
-
- 24
- 46
- 66
- 78
-
- 57
- 64
- 90
-
- 51
- 53
-
- 7
- 10
- 14
- 16
- 17
- 23

SCIENCE FAIR PROJECTS

Electro-Snoop—*modern as the jumbo jet, this Twentieth-Century electro-scope beats the old gold-leaf version hands down*
 Moving Coil Meter—*everything you need to know to build one of the most sensitive meters going*

PROJECTS FOR YOUR HOME

Wee Willie Wailer—*safeguards your home and drives the ghouls away*
 Cold Flash—*marks the exact location of most anything*
 FlashSwitch—*kills TV commercials like Wow!*

BONUS CONSTRUCTION PROJECTS

No Squint—*cheapie light protects all your test gear*
 PDQ React-or—*amazing device gauges your reaction time in PDQ fashion*
 IC Low Bander—*great little receiver tunes in on the mysterious down-under (like from 80 kHz right through the BCB)*

SCIENCE SPECIALS

The Skies Above Us—*how to capture a lunar eclipse*
 Great Men of Science—*Count Rumford (1753 - 1814)*
 Famous Patents—*Vladimir K. Zworykin's electronic eye*
 Our Dirty, Polluted Sea—*question is, can we save it?*
 The Sound of Silence—*eavesdropping on a world man does not hear*

FOR THE QUICKIE READER

In the Heat of the Night—*cartoon page*
 Doin' It for Doggies—*Fido deserves a better chance*
 VT Control for BT Addicts—*just what the babysitter didn't order*
 Music on the Rocks—*the eerie dankness of a stalactite organ*

COMMUNICATIONS—SWL/CB/HAM

Voodoo Radio—*strangest loggings on the DX scene*
 Ham Traffic—*the noose is getting tighter*
 Propagation Forecast

SPECIAL PRODUCT REPORTS

Mitchell's Uniflash—*studio-type electronic flash for the portrait specialist*
 API's Model 208 Home Burglar Alarm

REGULAR DEPARTMENTS

Positive Feedback—*Honorable Editor speaketh*
 New Products—*gadgets and gimmicks*
 Ask Me Another
 Stamp Shack—*pure philatronics*
 Bookmark—*by Bookworm*
 Literature Library—*get even with the PO*

White's Radio Log, Vol. 52, Part 4—page 81
Emergency Radio Services—Pacific Northwest—page 93

Cover illustration by Joe Rack

★
 Cover
 Highlights



Second class postage paid at New York, New York and at additional mailing office. Copyright 1970 by Science and Mechanics Publishing Co.

AMERICA'S GREATEST VALUES IN SCIENCE LABS AND COURSES!

American Basic Science Club's AMAZING KIT-A-MONTH PROGRAM

You Get **ALL** the following in **ten monthly kits!**

ELECTRICAL LAB

All the equipment for basic electrical experiments with Wheatstone Bridge, inductance resonator, Magnetizer and De-magnetizer, Thermocouple, Mystery Shock Box, Continuity Tester, Excitation Voltmeter, Johnson's Coin Tosses, Electro-magnetic Relay, Neon Lamp, Galvanometer, Induction Coil, Resistors, Chemicals and Electrodes for Piping and Electrolysis. **FOR SAFETY** a step-down isolation Transformer provides required current.



RADIO LAB AND COURSE

YOU BUILD A SHORTWAVE AND BROADCAST RADIO. 2-tube regenerative circuit, uses 115V AC. CARBON MICROPHONE with AUDIO AMPLIFIER. RADIO TRANSMITTER for call or voice. RIPPLE TANK WAVE GENERATOR with variable frequency invaluable in the understanding of wave theory. CODE PRACTICE OSCILLATOR with manual. Steps to a Ham License. All you need to pass the FCC home License Exam.



ATOMIC ENERGY LAB

ATOMIC CLOUD CHAMBER with PROJECTOR ILLUMINATOR. See the vapor trails of alpha and beta particles, and of cosmic rays. SPINTHARSCOPE. Shows exploding atoms. ELECTROSCOPE—metal housed with Stale and Magnifying Viewer. Measures background radiation and tests sample sources. SAFE RADIOACTIVE MATERIALS. Alpha Source in handy container and Uranium Ore. Full instructions and explanations open up the fascinating field of nuclear physics.



STROBE LIGHT

A Neon Lamp that flashes at intervals you can synchronize with the speed of rotating or vibrating objects in order to "freeze" their motion to permit close study and checking frequencies and RPM. Flashes are timed by a variable frequency oscillator with a range of 20 to 600 cycles per second.



RADIO SERVICING TOOLS

Signal Tracer SIGNAL TRACER. A valuable trouble shooting tool which permits you to "listen in" as you probe through a faulty circuit until you find the trouble spot. CONTINUITY TESTER. Pinpoints open circuits and test voltages. The use of both pieces fully described in accompanying manual. "Simplified Radio and TV Servicing".



SPECTROSCOPE

Analyze spectra of glowing gases. See and identify the Fraunhofer Lines. A quality instrument featuring an easy-to-read built-in scale and a powerful condensing system for a bright spectrum. Equipment includes Alkali Burner and a 2 Watt Neon Spectral Lamp. Full instructions cover theory and use.



PHOTOELECTRIC RELAY

Crystal Photo-cell, Electronic Amplifier, Relay, Large Condensing Lens in Cabinet Mount. Features automatic on-off or holding circuit operation. Sensitivity Control. Plug-in Outlet for controlled circuit. Use for alarms, counters, etc. Operates on 115V AC. A basic unit for many existing experiments.



DC POWER SUPPLY

Changes regular 110-120V AC to the direct current required for electronic projects and experimenting. Consists of a Power Transformer, Vacuum Tube Rectifier, 30/20 MFD Capacitor Filter, Circuit and a Precision Meter Voltage Selector. A Safe Isolated Power Supply eliminates the need of expensive multi-tube batteries.



ULTRAVIOLET LAMP

140 watt filter type UV LAMP. Heavy metal cabinet. A Ray Card, Rotary Switch. Produces dazzling color effects with invisible black light. Has many uses in the fields of Mineralogy, Crime Detection and Science. Includes Invisible Ink, Tracer Powder, Fluorescent Crayons.



ANALOG COMPUTER

Electronic Computer multiplies, divides, calculates powers, roots. Set up the problem on the scales of two potentiometers and find the answer on the scale of third potentiometer as indicated by a sensitive meter. Instruction Manual covers computer theory and practical use. Over 150 sample problems and answers demonstrate unit with fractions, trigonometry, logarithms, physics formulas, bolitics, etc.



MICROCRAFT LAB

Microprojector slows microscopic subjects enlarged with brilliant detail on wall or screen. Has sturdy Steel Cabinet, large Condensing Lenses for extra brightness, and a GE Projection Lamp. Microscope features Ramsden Eye-piece for wide field viewing, Substage Light and Polarizing Filter. Magnifies up to 200X. Includes: Slides, Cover Glasses and Microscopy Manual.



SURVEYOR'S TRANSIT

A practical Transit, 6X erect image telescope with Range-Finder. Verrier leveling for both horizontal and vertical scales. Leveling Head with Thumb Screw Adjustment and Spirit Level. Clamps under head hold wooden legs of Tripod. (Legs not included.) Instructions cover elementary surveying, range-finding.



LIGHT AND OPTICS LAB

Exciting optical projects for the study of light. Equipment includes: five Precision Lenses, Prism, Polarizing Filters, Diffraction Grating, Mirror, Telescoping Tube, Lens Mount, Tube Holders and Brackets. All the parts and instructions to build a Camera Obscura, Camera Lucida, Polariscopes, and many other optical devices.



PHOTOMICROGRAPHY CAMERA

Photographs subjects mounted on microscopic slides. Enlarges up to 100X. Takes clear, sharp pictures of specimens too small to be seen with the naked eye. A fully self-contained unit—no microscope required. Uses standard film, either 120 or 35, black and white or color. Make a photographic record of your projects with microscopic subjects.



TELESCOPE AND MOUNT

30X erect image. Extends to 30" length. Five ground and polished Lenses. Ramsden Eyepiece. Sturdy Equatorial Mount makes it easy to follow the movement of heavenly bodies. Mount has fittings for wooden legs that complete the tripod (legs not included). 1/2 turn for includes.



PHOTOGRAPHY LAB

A PRECISION 35MM ENLARGER... horizontal type with two condensing lenses and 3" f/11 projection lens. Produces quality enlargements up to 8"x10". Contact Print Frame makes negatives up to 3 1/2"x4 1/2". 3 Plastic Developing Trays, Neon Safelight, Tray Thermometer, Film Clip, Developing Chemicals, Fixing and Etching Paper and Darkroom Handbook. Make quality enlargements for 4x. Make prints for only 2¢. Full instructions.

LIGHT TRANSMITTER-RECEIVER

The TRANSMITTER consists of a Light Source, a Modulating Reflector Diagram and an Optical Projection System. The RECEIVER is a Two-Stage Audio Amplifier, controlled by a Photoelectric Cell that catches the projected light beam and causes the original sound waves to be reproduced in the loudspeaker. Talking on a Light Beam.

WEATHER STATION

A REMOTE READING ANEMOMETER AND WIND VANE... Flashing Neon Lights on indoor indicator board show wind speed and direction. Safety Power Cord makes all connections safe. 100 ft. of Lead in Wire. Plus—Air Tank Boreometer with air indicator column. Sling psychrometer measures relative humidity. Rain Gauge measures rainfall to 1/100 inch. ALSO Cloud Chart and Forecasting Manual—a complete set-up for amateur meteorology.

You get **ALL** the equipment for **ALL** the above in **ten monthly kits**

SEND **\$100** ONLY TO ENROLL PAY **\$4.95** FOR EACH KIT ONLY THAT YOU RECEIVE

Take as few as you wish—or get all ten... it's up to you!

SOME QUESTIONS ANSWERED

- Q. How is it possible? It seems incredible to be able to get all the equipment shown above in just ten kits—at only \$4.95 per kit!
- A. The direct-to-you, "no middleman", club plan is just part of the answer. The other key is ABSClub's especially designed multi-use equipment. For example: the Microprojector quickly and easily converts into the Spectroscope, Photo Enlarger and Cloud Chamber Illuminator. Similarly, the Transit doubles as a Telescope Mount. Such multi-purpose design... plus club plan economy... makes possible this all-science program at a price everyone can afford.

- Q. May members choose the order in which they receive their kits?
- A. Yes. With the first kit members receive a list of the equipment and projects contained in each of the remaining nine kits. With this information they are able to choose the kit sequence that best suits their particular interest.
- Q. Are there special tools or skills required?
- A. No. All you need are pliers and screwdriver. No soldering—new connectors make fast, firm joints. All equipment easy to use.

NO OBLIGATION—NO RISK!

- ★ You take only as many kits as you wish. No minimum—you may cancel anytime.
- ★ Two weeks approval on each kit you take. You may return any kit for full refund.

Send coupon today—get your first kit on its way!

AMERICAN BASIC SCIENCE CLUB, INC.
104 Heimann, San Antonio, Texas 78205

I wish to try the Kit-a-Month Program:

I enclose \$1.00 to enroll and \$4.95 for the first kit postpaid.

I enclose \$1.00 to enroll. Send first kit COD. I'll pay COD fee.

I understand if I am not satisfied with the first kit I may return it for a complete refund including the \$1.00 membership fee.

NAME _____

ADDRESS _____

CITY AND STATE _____ (PLEASE PRINT) ZIP CODE _____

AMERICAN BASIC SCIENCE CLUB, INC.

MAKE SCIENCE YOUR HOBBY!

NO EXPERIENCE NECESSARY—IT'S FUN! IT'S EASY!

1000's OF UNUSUAL SCIENTIFIC BARGAINS including...
SPECIAL UNIQUE PSYCHEDELIC LIGHTING
for Fun, Profit & Effects

VISUAL EFFECTS PROJECTOR SET

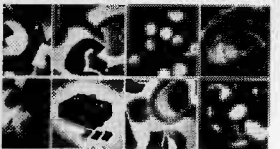

Dazzling, avant-garde visual effects. Fantastic variety. Incredibly beautiful. Special package offer contains all necessary apparatus. Creative lighting, exploding, fiery bursts of color like "Symphony of Spines", "Cosmic Starbursts", "Crystal Starbursts". Features 35mm 500 W. fan cooled projector—produces big image at short distance. Accepts two 9" diam. wheels (Dry Kaleidoscope & Hexidoscope), Cloud & 5" Hexidoscope w/ six entertaining parties, photography. Complete instructions.
 Stock No. 71,223HP \$79.50 Ppd.

3 CHANNEL COLOR ORGAN BARGAIN

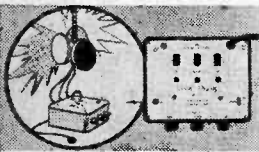

Create tremendous variety of unusual & beautiful lighting effects with this low-cost top quality, 1500 Watt unit (500 W. per channel). Compare with others selling for twice the price. Has pilot light, plus individual sensitivity controls & channel indicator lights. Can operate ten 350 W. "spots" or 200 Xmas lights. Use regular house current—attaches to audio source w/ RCA-type phono plug. 5 1/4" x 6 3/4" x 2 1/2" Hrs. Thermal setting plastic case, 6 ft. cord. Includes complete instructions.
 Stock No. 71,223HP \$34.95 Ppd.

LONG-WAVE BLACK LIGHT FIXTURE

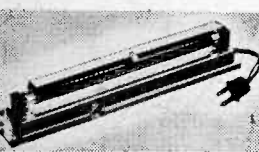

Extremely versatile, compactly designed, long wave (3200-4000 angstroms) black light (ultraviolet) fixture. Has 6-watt, 110-V lamp with built-in filter—eliminates harmful shorter wave ultraviolet rays. Use to identify minerals, fungus, bacteria—check for surface flaws, oil and gas leakage—perfect for displays with fluorescent cones, paints, chalk, crayons, trace powder. Incl. adjustable aluminum reflector. Mount vert. flat on or corner. 10" L., 1 1/2" W., 1 1/4" H.
 Stock No. 70,364HP \$12.50 Ppd.
 Stock No. 60,124HP REPLACEMENT BULB \$4.50 Ppd.

AMAZING "TRICK" PHOTOGRAPHY KIT



Now any amateur can produce all kinds of weird, wacky, out photo effects. No special knowledge or equipment required. Unique kit enables you to turn friends into monsters, show hoise with water to 2nd floor, make psycdelic slides, kaleidoscopic photos, impressionistic photo-art—unlimited possibilities. Complete instructions reveal the secrets—includes all accessories needed.
 Stock No. 71,229HP \$10.50 Ppd.

NEW \$99.50 HELIUM-NEON LASER!



Completely assembled, instant-starting w/three times power output of comparable models. Steady, ripple-free light of moderate (safe) power. Excellent collimation. Simple and safe to use. The 4 1/2 lb. unit reaches 75% power in 2 secs.; full power, typically 0.5 milliwatt (0.3 mW minimum) in 3 mins. Beam divergence only 2 milliradians—2 cms at 40 feet.
 Stock No. 79,004HP \$99.50 Ppd.

PSYCHEDELIC LIGHTING HANDBOOK



100 information packed pages! Fully explains the latest in psychedelic lighting equipment, techniques, developments. Covers all facets of psychedelic light-show oriented, including strobes, black lights, projectors, crystals, organic slides, mirrors, color organs, polarized light boxes, MusicVision, etc. Shows how to group "psychedelic" parties, musical "shows". Shows how to set up "electric trips" for your own private gatherings. 8 1/2" X 11" ring binder. Add new developments as they happen.
 Stock No. 9100HP \$3.00 Ppd.

Order by Stock No.—Check or M.O.—Money-Back Guarantee
EDMUND SCIENTIFIC CO., 300 Edscorp Bldg., Barrington, N.J. 08007

WRITE FOR GIANT FREE CATALOG "HP"



Completely new edition. New items, categories, illustrations. 118 easy-to-read pages packed with 4000 unusual items. Dozens of electrical and electromagnetic parts, accessories. Enormous selection of Astronomical Telescopes, Microscopes, Binoculars, Magnifiers, Magnets, Lenses, Prisms. Many war surplus items; for hobbyists, experimenters, workshops, factory. Write for catalog HP. Include Zip.

ORDER BY STOCK NUMBER - SEND CHECK OR MONEY ORDER - MONEY-BACK GUARANTEE
EDMUND SCIENTIFIC CO. 300 EDSCORP BUILDING
 BARRINGTON, NEW JERSEY 08007

Science and Electronics

Volume 28 Number 4

JULIAN M. SIENKIEWICZ, WA2CQL
Editor-in-Chief

RICHARD A. FLANAGAN, KQD2566
Managing Editor

CHARLES S. HARRIS
Technical Editor

ROBERT WOLLINS
Assistant Editor

HELEN PARKER, KQD7967
News Editor

JIM MEDLER
Art Editor and Associate Art Director

ARTHUR S. COOKFAIR; WEBB GARRISON;
ERNEST A. KEHR; MARSHALL LINCOLN,
W7DQS; ROY K. MARSHALL, PH.D.; JACK
SCHMIDT
Contributing Editors

JOSEPH A. D'AMATO, Art Director
IRVING BERNSTEIN, Cover Art Director
DAVID J. MILLER, KCX7268, Advertising Director
CARL BARTEE, Production Director
GERTRUD BORCHARDT, Production Manager
MARILYN VARGAS, Assistant Production Manager
WILFRED M. BROWN,
Instruments Division Manager
ROGER G. CAVANAGH,
Circulation and Marketing Director

B. G. DAVIS, Chairman of the Board
JOEL DAVIS, President and Publisher
LEONARD F. PINTO,
Vice-President and General Manager
VICTOR C. STABILE, KBP0681,
Vice-President and Treasurer

SCIENCE AND ELECTRONICS is published bi-monthly by Science & Mechanics Publishing Co., a subsidiary of Davis Publications, Inc. Editorial, business, and subscription offices: 229 Park Avenue South, New York, N.Y. 10003. One-year subscription (six issues)—\$4.00; two-year subscription (12 issues)—\$7.00; and three-year subscription (18 issues)—\$10.00. Add \$1.00 per year for postage outside the U.S.A. and Canada. Advertising offices: New York, 229 Park Avenue South, 212-OR 3-1300; Chicago, 520 N. Michigan Ave., 312-527-0330; Los Angeles, J. E. Publishers Rep. Co., 8560 Sunset Blvd. 213-659-3810; Long Island, Len Osen, 9 Garden Street, Great Neck, N.Y., 516-487-3305; Southwestern advertising representative: Jim Wright, 818 Olive St., St. Louis, 314-CH-1-1965.

EDITORIAL CONTRIBUTIONS must be accompanied by return postage and will be handled with reasonable care; however, publisher assumes no responsibility for return or safety of manuscripts, art work, or photographs. All contributions should be addressed to the Editor, SCIENCE AND ELECTRONICS, 229 Park Avenue South, New York, N.Y. 10003.

Second class postage paid at New York, New York and at additional mailing office. Copyright 1970 by Science and Mechanics Publishing Co.



POSITIVE FEEDBACK

Julian M. Sienkiewicz
EDITOR-IN-CHIEF

I can remember the time when a purchaser of a new television receiver was in store for some unique headaches. Today, the sands of time have drifted into the works of another consumer product. To prove a point, sit down and chat with a friend who purchased a new car in the last few weeks—and try to understand why his tears are genuine. Only recently, this editor had the “good fortune” to borrow a new station wagon for a vacation trip. The car had just 45 miles on the odometer when I pulled away from the curb into a most unforgettable experience.

Here are just a few of the wagon's defects: rear window jammed halfway down and must be forced the remainder of way, rear tailgate door didn't open, lock on rear door came apart in child's hand, fuel and ammeter dials were always fogged after rain (and couldn't be read), parking brake light was always *on*, spark plug was left unconnected (even after dealer's tune-up!), driver's door had to be slammed by grown man to shut properly, license plate light fell out of bumper, driver's manual was incomplete on the matter of how to drop rear seat, front seat could not be positioned forward or back, and last but not least—the car's electrical system failed on a major parkway at the height of the rush hour in a rainstorm. How do you like them apples?

Now let me tell you about my new color TV set. It's been working without fail for over a year. And this story is heard from many set owners of different makes. TV receivers are made more and more reliable each year and color sets are no exceptions! The weakest link in any set is the antenna, but the master antenna system (MATV) I installed recently (it's a Finney) goes a long way toward ensuring perfect reception.

The consumer electronics industry is really delivering. What's wrong with Detroit?

Action—At Last. After nearly six years of combined efforts by CB operators and manufacturers, the FCC has authorized use of channel 9 for transmission of emergency communications *only*, including highway assistance. Channel 15 will be the new interstation channel to replace channel 9. Looks like CB is moving ahead again. Yipee!

how often could you have used...

a Seizer?

two-position
snap-lock

**Handy as an
extra hand or helper.
Clamps lightly or tightly . . .
for moments or minutes.**

A remarkably versatile tool with unusual holding qualities. Clamps tightly. Holds wires for soldering, acts as a heat sink, retrieves small parts from hard-to-reach places. Two-position snap-lock. Box joint construction. Precision machined from perfectly tempered stainless steel.

4 MODELS: 6" (serrated jaws) Nos. 42H straight and 43H curved nose; 5" Jr. (smooth, slim jaws) Nos. 32H straight and 33H curved nose.

XCELITE

XCELITE, INC., 64 Bank St., Orchard Park, N. Y. 14127
Send Bulletin N564 on Seizers®.

name _____
address _____
city _____ state & zip _____

In Canada contact Charles W. Pointon, Ltd.

8 New Action-Packed Kits From Heath —



Heathkit GD-101
\$49.95*

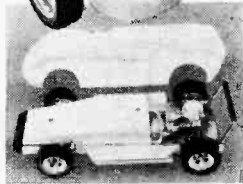

NEW Heathkit "Spectre" 1/8 Scale R/C Car Join The Most Exciting New Hobby In America . . .

building and racing radio-controlled Grand Prix cars up to scale speeds of 200 mph. The Heathkit "Spectre" R/C car reaches that speed and has already proven itself a winner. And no wonder; its design is unique. It has a chrome plated steel chassis, adjustable caster and toe-in, specially formulated rubber tires that lock onto the cast nylon wheels, independent front suspension for excellent cornering and a 5.5:1 gear ratio for maximum torque at all speeds. The snap on, 1/8 scale car body (length: 19 3/4") is of high impact plastic — almost indestructible. Suspension is by real coil springs. The radio equipment compartment is dirt and oil proof. The Heathkit "Spectre" is the only complete car kit available. You get the body, chassis, wheels & tires, 4 oz. fuel tank & tubing, equipment case & protective foam, centrifugal clutch & gears, axles, servo linkages & mounting tape, all hardware, decals, numbers and a comprehensive manual. The "Spectre" accepts any .15 to .23 cubic inch R/C engine and any proportional R/C electronics system. It requires only two servos to operate the steering, brake and throttle. Get in on all the thrills of R/C car racing at the lowest possible price . . . order a Heathkit "Spectre".

Kit GD-101, R/C car only, 8 lbs. \$49.95*
Assembled GDA-101-1, Veco .19 R/C engine, 1 lb. \$19.95*

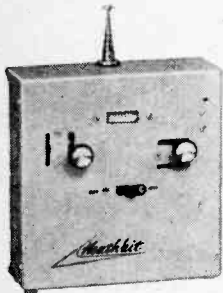

Heathkit GD-57
\$129.95*

NEW Heathkit 3-Channel Digital Proportional R/C System For Planes, Gliders, Cars And Boats

Ideal for use with the new Heathkit "Spectre" R/C car to give you total control . . . ease of handling. Here's what the Heathkit GD-57 R/C system includes: Transmitter with assembled, factory aligned RF circuitry; new 2 oz. miniature receiver that needs no IF alignment, in a tough nylon case; you also get two servos; all plugs; connectors; cables; charging cord; new flat-pack rechargeable nickel-cadmium transmitter and receiver batteries . . . and a special soldering iron. You can have your choice of five operating frequencies in each of three bands . . . 27, 53 or 72 MHz. This is the most value ever offered in a 3-channel rig.

Kit GD-57, transmitter, receiver, 2 servos, batteries, charging cord, switches and soldering iron, (specify freq. desired), 11 lbs. \$129.95*
Kit GDA-57-1, transmitter, battery, charging cord, (specify freq. desired), 5 lbs. \$54.95*
Kit GDA-57-2, receiver only, (specify freq.), 1 lb. \$34.95*



Battery Pack

Servos

Heathkit Siren & Speaker
\$99.95*

NEW Heathkit Siren/PA For Licensed Emergency Vehicle Only

Hey Chief! Save up to 60% on a new electronic siren/PA system by ordering the low cost Heathkit GD-18. The siren gives both "wail" and "yelp" warnings at 55 watts output power, and you can adjust the pitch. As a public address it will amplify your voice with a full 20 watts of power, and it's practically immune to acoustical feedback. (Either PA or siren can be interrupted to use the other.) Incoming radio calls can be channeled through the GD-18 so you can hear them when away from your vehicle. Use it on any 12-volt auto electrical system with either positive or negative frame ground. It will operate from -20° to 150° F conditions. Control panel is lighted. Comes with gimbal bracket mounting. Take your choice of speakers . . . concealed or exposed.

Kit GD-18, Siren/PA Amplifier, 7 lbs. \$54.95*
Assembled GDA-18-1, Exterior Horn, 9 lbs. \$49.95*
Assembled GDA-18-2, Concealed Horn, 4 1/2 x 4 1/2 x 13", 9 lbs. \$49.95*
System GD-18A, (includes GD-18 plus exterior horn), 16 lbs. \$99.95*
System GD-18B, (includes GD-18 plus concealed horn), 16 lbs. \$99.95*



Amplifier & Controls



Exterior Horn

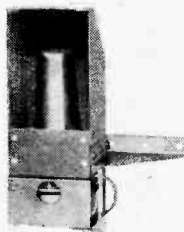

Concealed Horn

Heathkit MI-29
\$89.95*

NEW Heathkit Solid-State Portable Fish Spotter

Costs half as much as comparable performers. Probes to 200 ft. Doubles as depth sounder. Transducer mounts anywhere on suction cup bracket. Adjustable Sensitivity Control. Exclusive Noise-Rejection Control stops ignition noise. Runs for 80 hrs. on two 6 VDC lantern batteries (not included). Manual explains typical dial readings. Get set for next season; order your Heathkit MI-29 today.

Kit MI-29, 9 lbs. \$89.95*



The Value Leader



NEW Heathkit 5-Band SSB Amateur Transceiver

The new Heathkit SB-102... proud successor to the famous "100" & "101". You can expect top performance and value from this rig... and you get it. An all solid-state Linear Master Oscillator delivers faster warmup, greater stability and better tracking... new receiver circuitry gives better than 0.35 uV sensitivity for real performance under bad band conditions. Plus all the features that made the SB-101 the world's most famous, most popular transceiver... 180 watts PEP SSB input... 170 watts CW input... 80 through 10 meter coverage... USB, LSB or CW modes... built-in VOX or PTT operation... built-in CW sidetone... built-in 100 kHz crystal calibrator... Triple Action Level Control for reduced clipping & distortion... fast, easy bandswitching and tune-up... rugged, inexpensive 6146 finals... separate headphone level control & front panel jack... simple assembly with circuit board-wiring harness construction... sharp Heathkit SB-Series styling plus many more features. Order yours now.

Kit SB-102, 23 lbs.....\$380.00*
Kit SBA-100-1, mobile mt., 6 lbs.....\$14.95*



Heathkit SB-102
\$380.00*

NEW Heathkit 60-Watt AM-FM-FM Stereo Receiver

Superb stereo performance at budget price, that's the new Heathkit AR-19. A giant, electronically regulated power supply provides 60 watts IHF music power (ideal for all modular and high efficiency speaker systems)... frequency response is -1 dB from 6 Hz to 35,000 Hz... and Harmonic & IM distortion are less than 0.25% at any output. This advanced performance assures you of crisp, clean highs without ringing or breakup... solid, clean-cut lows without distortion — just pure, uncolored sound reproduction at all frequencies and power levels. The FM Stereo circuitry is unequalled by any receiver in this price class... a factory assembled & aligned FET FM tuners... superior overload characteristics & 2.0 uV sensitivity... a factory assembled & aligned FM IF circuit board with 4 IC's for superior AM rejection, hard limiting, greater stability and 35 dB selectivity... a precision ball-bearing inertia flywheel for smooth, precise tuning... two front panel tuning meters for exact station selection. Other features include modular snap-out circuit boards, built-in self-servicing capability, hi-fi AM reception and much more. Make the AR-19 the heart of your stereo system now.

Kit AR-19, 29 lbs.....\$225.00*
Assembled AE-19, oiled pecan cabinet, 10 lbs.....\$19.95*

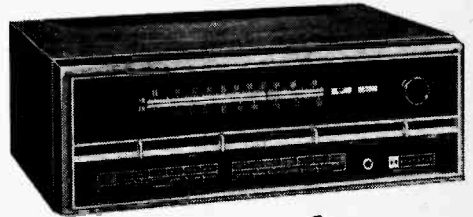

Heathkit AR-19
\$225.00*

Heathkit Solid-State Metal Locator

Here's versatile, professional performance in a metal locator at lowest cost. The all solid-state GD-48 uses a unique induction balance detection system that doesn't produce a tone until metal enters the search field... eliminates having to listen for a change in tone. The built-in Sensitivity control allows adjustment to detect varying size objects down to 6 feet. A built-in speaker audibly signals presence of metal... for higher sensitivity use the accurate front-panel meter. And the front-panel headphone jack lets you use headphones to screen out annoying background noise. Look no further for an excellent metal locator... order the GD-48 now.

Kit GD-48, 4 lbs.....\$69.95*
GDA-48-1, 9 V battery, 1 lb.....\$1.30*

Heathkit GD-48
\$69.95*



Heathkit Screw-Drive Radio-Controlled Garage Door Opener Now Costs Less

Like having a personal doorman. The powerful yet gentle screw-drive door mechanism gives you ease & convenience you want with the reliability & safety you need. Just a touch of a button and the factory assembled & aligned UHF electronics open your garage door from up to 150 ft. away and turns on a light too. Once inside, another push of the button closes the door safely behind you, yet the light remains on long enough for you to enter your home. Fast, easy one-night assembly... all wires pre-cut with connectors installed... no soldering. Fits any 7 1/2" overhead, jamb or pivot single or double size residential doors. Automatic instant reverse feature prevents injury to kids, pets, etc. Send for yours now.

GD-209A, mechanism, receiver & transmitter, 66 lbs.....\$139.95*
GD-209B, mechanism, receiver & 2 transmitters, 66 lbs.....\$149.95*



New Lower Price
Kit GD-209A
\$139.95*



NEW
FREE 1970 CATALOG!
Now with more kits, more color. Fully describes these along with over 300 kits for stereo/hi-fi, color TV, electronic organs, guitar amplifiers, amateur radio, marine, educational, CB, home & hobby. Mail coupon or write Heath Company, Benton Harbor, Michigan 49022.

HEATH COMPANY, Dept. 19-8 Benton Harbor, Michigan 49022		HEATHKIT <small>a Schlumberger company</small>	
<input type="checkbox"/> Enclosed is \$ _____, plus shipping.			
<input type="checkbox"/> Please send model (s)		<input type="checkbox"/> Please send Credit Application.	
Name _____			
Address _____			
City _____		State _____	Zip _____
*Mail order prices; F.O.B. factory. Prices & specifications subject to change without notice. CL-386			

***** **NEW**

How to Be Tidy When Soldering

A combination soldering iron holder and rotary tip wiper, the Plato TWH-444 prevents iron burns, eliminates iron overheating, and increases operator efficiency. The unit incorporates the Plato TW-555 rotating tip wiper and a heavy wire double spiral iron holder mounted on a durable metal base with non-skid feet. The outer spiral of the holder prevents

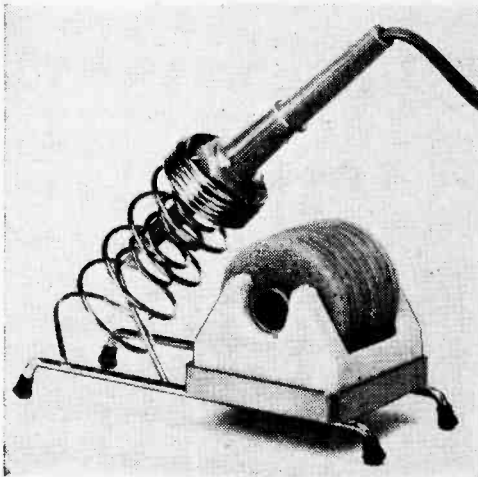

Plato Soldering Iron Holder/Tip Wiper

the operator from touching the iron accidentally, while the inner spiral retains the iron securely and serves as a heat sink. Unit's design permits removal of the iron and cleaning of the tip in one continuous motion. The TWH-444 accommodates irons to 60-watt size. The complete unit is priced at \$5.95; for further information write Plato Products, Inc., Box 1019, El Monte, Calif. 91734.

Bingo Bango Bongo

If you want to pretend you're in the tropics, you can add a calypso beat to your group with Knight-Kit's new solid-state Electronic Bongo Kit, model KG-391. You just plug the Bongo



Knight-Kit Electronic Bongos

SCIENCE AND ELECTRONICS

Olson
ELECTRONICS
FREE
Catalog

Fill in coupon for a **FREE** One Year Subscription to **OLSON ELECTRONICS'** Fantastic Value Packed Catalog — Unheard of **LOW, LOW PRICES** on Brand Name Speakers, Changers, Tubes, Tools, Stereo Amps, Tuners, CB, and other Values. Credit plan available.

NAME _____
ADDRESS _____
CITY _____ STATE _____
GIVE ZIP CODE _____

If you have a friend interested in electronics send his name and address for a **FREE** subscription also.

OLSON ELECTRONICS
DEPT. M-HI 260 S. FORGE STREET, AKRON, OHIO 44308

Technical Excellence in Electronics

On our small friendly campus the emphasis is on Living as well as Learning. Extra-curricular social activities, student clubs, a student-operated radio station, student government, new dormitory, a full sports program help provide a world of your own in which to prepare for the world of tomorrow. Diploma in Electronic Technology and Associate Degree in Electronic Engineering Technology. B. S. obtainable. GI approved.

VALPARAISO TECHNICAL INSTITUTE
DEPT. SE VALPARAISO, INDIANA 46383



TUBES! CORNELL TUBES!

FREE Send For FREE
CORNELL'S
New 1970
CATALOG
Many New Items

30¢ per tube
IN LOTS OF 100

33¢ per tube
WE SELL
PICTURE
TUBES

4219 E UNIVERSITY AVE., SAN DIEGO, CALIF. 92105

TREASURE

Find buried gold, silver, coins, treasures.

5 Powerful models.

Write for free catalog



DEPT. D-58 **\$19.95** UP
BOX 10839, HOUSTON, TEX. 77018

PRODUCTS

Kit into your amplifier and tap the bongo heads with your fingertips as you would real bongo drums. The unit has a high and low bongo head, each with its own sustain control for varying the tone and making authentic-sounding noises. There's a volume control and on/off slide switch. The KG-391, which uses one 9-V battery, comes complete with wood base and step-by-step instructions; the price is \$12.95. For further information write Allied Radio Corp., 100 N. Western Ave., Chicago, Ill. 60680.

Well-Dressed PCB Wears Soder-Mask

Soder-Mask is a liquid elastomer solder resist and coating mask that protects contacts, holes, and areas on printed-circuit boards that must be kept solder-free when boards are ma-



Solder Removal Company Soder-Mask

chine soldered. Soder-Mask is available in two types: regular and water soluble. The regular formula can be removed after soldering by peeling or rubbing. The water-soluble type is removed by washing in hot water. Either type can be applied by brushing, applicator, or syringe needle and will cure to form a tough coating which will withstand soldering temperatures of 500 to 550°F. Soder-Mask will also take a bake temperature of 300°F. for several hours, so it can be used as paint resist when coated, painted, or varnished parts must be oven cured. Soder-Mask is packed in 4-oz plastic bottles with applicator tips. Price is \$2.49, and you can get more info from Solder Removal Co., Box 1678, Covina, Calif. 91722.

(More on page 12)

New SAMS Books

Transistor Substitution Handbook, 10th Edition

Updated to include thousands of substitutions for all types of bipolar transistors: U.S. and foreign, home-entertainment and industrial. Computer-compiled for accuracy. Also includes manufacturers' recommendation for general-replacement transistors. Order 20773, only.....\$1.95

Color TV Training Manual, 3rd Edition

Best guide for technicians preparing to service color TV. Includes detailed explanation of color principles, circuits, setup procedures, alignment, and troubleshooting; full-color illustrations. Order 20736, only.....\$6.95

ABC's of Air Conditioning

Explains in simple language the laws of physics which relate to air conditioning and how these laws are applied practically in the design and manufacture of all types of air conditioning units and systems. Order 20725, only.....\$2.95

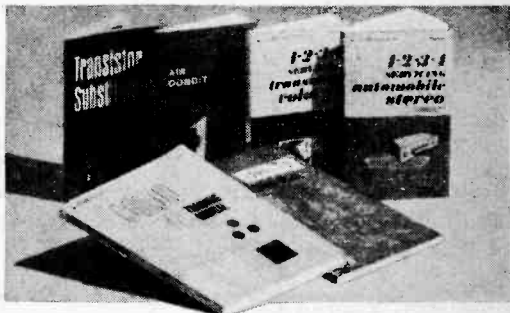

1-2-3-4 Servicing Transistor Color TV

The ingenious "1-2-3-4" servicing method is applied here to the repair of transistor color TV sets. Covers the fundamentals of transistor color circuitry; explains how to apply the method for quick, easy troubleshooting and repair. Order 20777, only.....\$4.95

Tape Recorder Servicing Guide

Explains in detail the principles of magnetic recorder circuitry. Describes components and systems and provides comprehensive instructions for preventative maintenance, adjustments, and repair. Order 20748, only.....\$3.95

1-2-3-4 Servicing Automobile Stereo

This book first explains the electronic and mechanical principles of automobile stereo, fm multiplex, and tape cartridge systems; then shows how to apply the "1-2-3-4" method for quick troubleshooting and repair. Order 20737, only...\$3.95

HOWARD W. SAMS & CO., INC.

Order from any Electronic Parts Distributor, or mail to Howard W. Sams & Co., Inc. Dept. RT-080 4300 W. 62nd St., Indianapolis, Ind. 46268

Send the following books: Nos. _____ \$ _____ enclosed

Name _____

Address _____

City _____ State _____ Zip _____

Spray-On Insulation

This new aerosol spray from Chemtronics is a refinement of their 10-year-old formula, NO-ARC. The new NO-ARC leaves a tough, thick protective red insulating coating capable of withstanding up to 30,000 volts. It's recommend-



Chemtronics NO-ARC Spray

ed for stopping arcing and corona shorts in high-voltage circuits, especially on color chassis. NO-ARC is also suggested for potting components, and for water-proofing and insulating printed-circuit boards and exposed wiring. You get 8 oz. for \$2.79. For more dope (sic), write Chemtronics Inc., 1260 Ralph Ave., Brooklyn, N.Y. 11236.

Decline of the Empire (In Price)

Empire announces that they've finally produced a 3-way, high powered, omnidirectional,

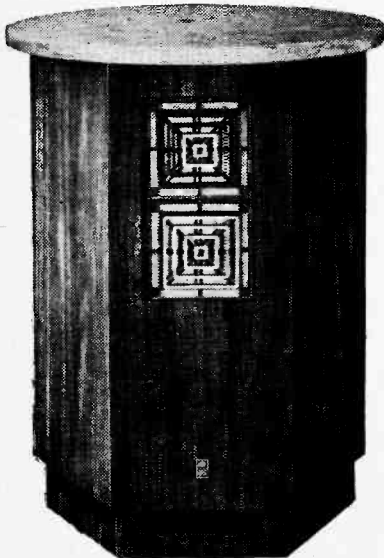

Empire 6000 Grenadier Speaker

down-facing woofer, wide-angle lens speaker system priced under \$100.00. The Empire 6000 Grenadier has three drivers, an ultrasonic domed tweeter, a powerful midrange radiator for full presence, and a heavy 10-in. down-facing woofer that sends out its low frequencies through a complete circle. The 6000 Grenadier will handle up to 75 watts per channel, and has a frequency range of 30 to 20,000 Hz at 8 ohms. Diameter is 18 in., height 24 3/8 in. Price with walnut finish top is \$99.95; with a marble top it's \$109.95. For more detailed specs, write Empire Scientific Corp., 1055 Stewart Ave., Garden City, N.Y. 11530.

On Lancer . . . On . . .

You CBers will want to know about the new Lancer 500 series of mobile antennas from Mosley. Each model, 500A, 500B, 500C, features a high-Q coil, resulting in reduced mechanical height while maintaining power capability up to 500 watts. They also use a new guying device, located just above the coil, which prevents antenna lay-back even at top highway speeds. The Lancer 500 antennas are factory pre-tuned to minimum VSWR of 1.5 to 1 or better. There's a hinge feature so that antennas may be lowered and secured from either trunk or bumper mounting position. Each antenna is topped with a static ball to reduce corona effect and prevent loss of power. Prices are: 500A, \$17.75; 500B, \$22.85; 500C, \$27.50. For more info write to Mosley Electronics Inc., 4610 N. Lindbergh Blvd., Bridgeton, Mo. 63042.

Mosley Lancer CB Antenna →

Beginners, Here's Luck

Knight-Kit has a new, easily-assembled, tube-type AM table radio kit for all you students and beginners in electronics hobbying. Model KG-311 will give you a good working knowledge of superheterodyne radio circuits. It has 4 tubes, a rectifier, and automatic volume control. Unit operates on AC and tunes the standard 535-1650 kHz AM radio band. Size is 5 1/4 x

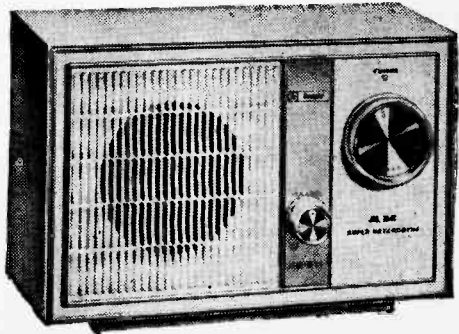

Knight-Kit AM Table Radio Kit

7 $\frac{3}{4}$ x 4 in., and it comes with ivory plastic case and detailed assembly instructions. Price is a mere \$9.95; for full information, write Allied Radio Corp., 100 N. Western Ave., Chicago, Ill. 60680.

Stranded on Your Stranded Wire?

With these new 4 $\frac{3}{8}$ -in. cutters from the Brookstone Co. you'll have really neat slicing of insulation and/or stranded conductors. Their shape eliminates usual messy cuts with conductor strands mashed and spread apart, and

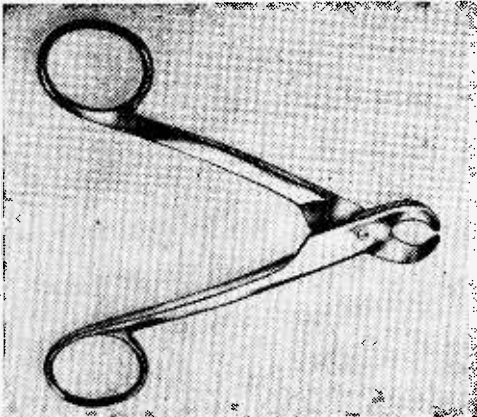

Brookstone 4 $\frac{3}{8}$ -In. Cutters

they'll also cut solid conductor wire. Suitable for copper and aluminum wire from the finest up to about $\frac{1}{2}$ -in. diameter over insulation, the cutters are forged of top-quality high-carbon steel and priced at \$4.45. Sold only by mail from Brookstone Co., 539R Brookstone Bldg., Peterborough, N.H. 03458.

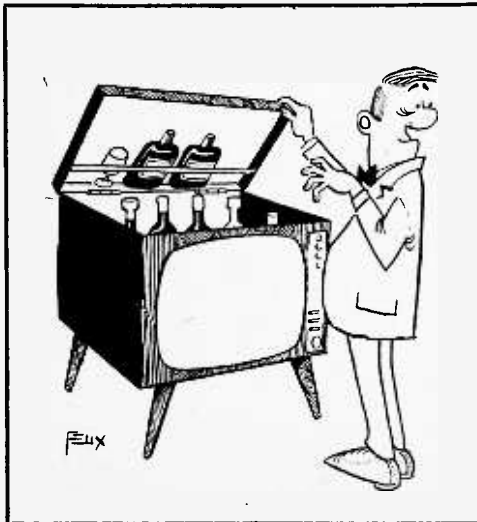

You miss plenty...

when you miss a single issue of



NEW DEVELOPMENTS in the world of electronics come so fast these days that there's hardly a field where there aren't new application breakthroughs.

THAT'S WHERE the bigger and better coverage you find in every issue of **SCIENCE AND ELECTRONICS** comes in. It keeps you posted on the really important developments in language you don't have to be an engineer to understand...with diagrams you can easily follow.

DON'T RISK missing the kind of reading that has made **SCIENCE AND ELECTRONICS** (formerly Radio-TV Experimenter) must reading every issue for practicing electronics hobbyists—amateurs, SWLs, CBers, experimenters, project builders.

You can SAVE PLENTY when you use the coupon below ▼

BE SURE of every issue by subscribing now...and you'll be saving over the cost of buying your copies on the newsstand...and you'll never miss an issue because the postman will bring it right to your door. Clip and mail the coupon today.

Science and Electronics Dept. 272
229 Park Avenue South New York, N. Y. 10003

I don't want to miss a single issue. Enter my subscription for:

- 3 years — 18 issues — \$10
SAVING ME \$3.50 over the newsstand price
- 2 years — 12 issues — \$7
SAVING ME \$2.00 over the newsstand price
- 1 year — 6 issues — \$4
SAVING ME 50¢ over the newsstand price
- I enclose \$_____ Please bill me

NAME _____
STREET ADDRESS _____
CITY _____
STATE _____ ZIP CODE _____

Outside U.S. and Canada: Add \$1.00 per year



They'll Sell Anything

I recently saw an ad in a magazine on a "revolutionary" new omnidirectional outdoor antenna which the ad says will pull in TV (uhf and vhf), AM broadcast, FM stereo multiplex signals from every direction over a 75-mile radius. The ad also states that the antenna outperforms costly roof antennas 20 times its size. The illustration in the ad depicts the antenna as a small cylinder mounted on the side of a house and on a window sill. Since it's advertised for \$12.98, how can it compare with a much more expensive antenna?

—C.J.S., Flushing, N.Y.

We don't believe the claims. Apparently some enthusiastic ad copy writer got carried away with himself without knowing much about TV reception. We also saw the ad which states "color pictures come in snow-free and stable in color and contrast." Under some conditions

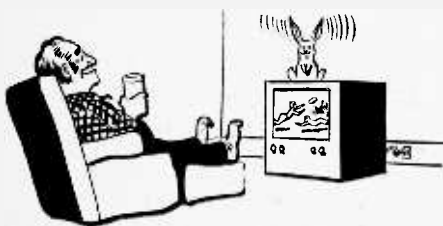

this might occur, but we are betting against it with the odds in our favor. The ad also states "you couldn't get better results from a motorized antenna system selling for 10 times the price." Frankly, we've looked inside the cylinder antenna and at the guts of other exotic devices offered in the past. For the most part they are just junk wiring packed into a plastic handsome case. In fact, the case brings in the \$12.98 checks. Too bad the guts inside cannot bring in the signal. One key word to remember when reading these ads and that's *omnidirectional*. An omnidirectional antenna—an anten-

na that picks up signals from all directions—picks up signals from stations as well as ghosts. This is bad for any kind of TV reception.

Who Owns It Now?

I have a Cadre 501 citizens band transceiver that needs repair. My problem is that of finding replacements for the transistors in the transmitter section. One company quoted me a price on the exact replacements but the price is more than I want to pay for such an old unit. There's bound to be replacements for these transistors at a reasonable price.

—G. A., Rosenberg, Texas

The Cadre CB product line was bought by Amphenol then sold to Commander Electronics, 133 N. Jefferson St., Chicago, Ill. 60606. Commander should be able to help you.

A 50-Foot Pole?

I purchased a Lafayette (30-50 MHz) fire radio and a ground-plane antenna about three years ago. I always tune to county fire stations. I receive base-station dispatchers fairly well and get very little reception of mobile units. Could you please tell me how I could stepup reception so I can receive everything in that band?

—G.P., Glen Cove, N.Y.

Don't expect to hear mobile units well unless your antenna is very high above surrounding terrain. Bear in mind that you are listening to transmitters ranging in power from 15 to 100 watts compared to broadcast stations putting out 50,000 watts. You could get a vertically polarized beam antenna and a rotator and install them on a telephone pole or tower at least 50 ft high. But, is it worth the investment?

Did You Hear That Pane

Newspapers report the development of a laser microphone. Aimed at a windowpane, its beam would be modulated by the vibrations of the pane caused by conversion on the other side. If this mike is in production, planned for production, or if plans for building it are available, I would appreciate your letting me know.

—E.K., Chicago, Ill.

If it is in production, you probably couldn't afford one. Furthermore, using it would be an invasion of privacy. There's too much of that going on. Why don't you stick to party-line eavesdropping or get a 7X35 binocular. Do it like father did!

Buy New!

I have a Sears tape player which I would like to convert into a recorder. Is this possible without too great an expense, and if so, how?

—E. F., Lockport, Ill.

The expense might not be great, but the trouble would be. This is a mechanical project much more than electronics. Also, very few people can mount and align record heads. ■

You can now get a confirmed & guaranteed car reservation from National Car Rental in less than a minute.

From all those other guys all you can get is a very sincere promise.

It's not that those other big city car outfits ever *mean* to leave you without wheels. It's just that at the moment they promise you a car they have no real way of knowing for sure that it will be there.

National does. Us country boys from Minnesota now have Max, the computer. You can call us for a reservation any time from anywhere in the U.S. toll-free by dialing 800-328-4567. Max knows, at the instant you call, what cars are available everywhere in the U.S. Before we guarantee your reservation, we talk to Max.

When you reserve a National Car at any of our locations, you also know you'll have your choice of a GM or other fine make, and that you'll get a fistful of free S&H Green Stamps.

It's your choice: a sincere promise or a National Guarantee. You can get either in about the same length of time.

**NATIONAL
CAR RENTAL**



We make the customer No. 1

A SINCERE
APOLOGY, TOO,
MAYBE?

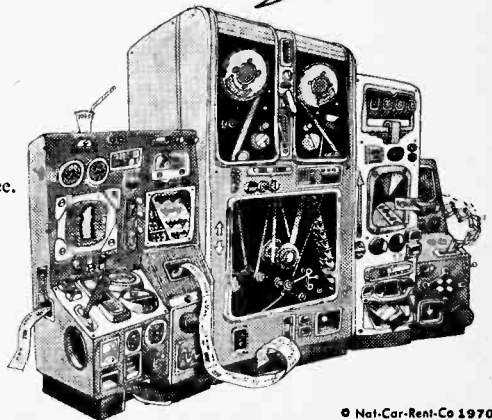

© Nat-Car-Rent-Co 1970
In Canada and throughout the world it's TILDENterNATIONAL

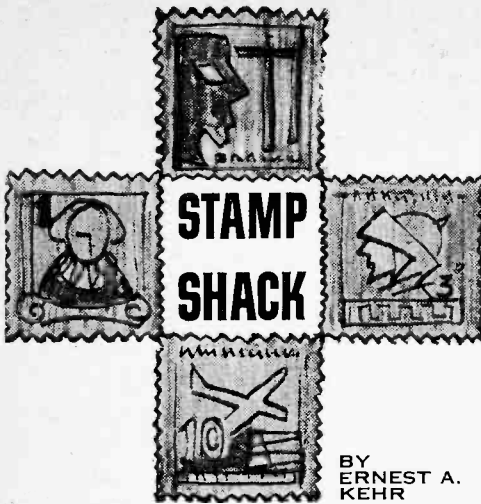

● ● Now that satellites are orbiting 22,000 and more miles over our oceans all over Outer Space, nations around the globe are opening earth stations to take advantage of this revolutionary communications facility that augments terrestrial telephone and telegraph service.

● And just as fast as buildings are completed, postal administrations are producing special stamps to commemorate the linking with Intelsat systems. In recent months, Argentina, China and Hongkong have turned out colorful postal paper to mark the dedication and operations of their costly earth stations able to send and receive message signals via the Intelsat satellites.

● The idea of using Space satellites to bounce commercial signals from one part of earth to another began with "Early Bird," in 1965. Lani Bird I, II and III were subsequently launched and now hover over the Atlantic, Pacific and Indian Oceans, each capable of handling some 240 individual channel on a simultaneous basis. Now, with the orbiting of three more—the Intelsat III's—additional facilities have been added to supply 3,600 more channels to speed Man's messages.

● ● The Argentinian issue comprises two values: 20 peso, which shows a montage of the earth station with its immense "dish" antenna pointed skywards towards the Intelsat III, and 40 peso, which shows another view of just the station. The station has been erected in Balcare,

in an open area some 300 miles south of Buenos Aires, and which is both capable of handling all telecommunications needs today and of being enlarged as demands for service increase in the future. Costing some \$6 million, it was opened in December, 1969, with a live TV program in which Pope Paul appeared with greetings to the Argentinians from the Vatican. In Buenos Aires, President Juan Carlos Onganía thanked His Holiness and introduced Antonio Cardinal Caggiano, Catholic prelate of Argentina.

● ● China's stamps include three denominations (\$1, \$5 and \$8 in local currency) and depict the Intelsat III flying through star-dotted heavens over the earth station. This facility is located on the hills of Chin-Shan-Li Yangming-shan, a short ten miles from Taipei.

● ● Hongkong's commemorative consists of a single \$1 denomination in which designer V. Whitely shows its dish antenna and the Intelsat III framing an outline globe surrounded by waves symbolizing earth-space signals. Hongkong's facilities were constructed by Cable and Wireless, Ltd., at Stanley Peninsula which juts into the China Sea between Repulse Bay and Tytam Reservoir on the southern end of Hong Kong Island. Cost estimates were submitted by the United States, Canada, Japan, Italy and Germany, but the £2,500,000 contract finally was let to British Marconi, Ltd.

● Hongkong long has served as a vital Asian communications point, especially for newsmen and business firms because of its convenient political independence in that part of the Orient so disturbed by wars and rumors of wars. In opening the station for business, the British colony promised that it would "mark a significant advance in an already highly-developed telecommunications point with links to the rest of the world."

● The new antenna, whose "dish" is 90 feet in diameter, will enable Cable and Wireless to transmit and receive messages via Intelsat from Japan, Hawaii, the United States, Australia and Thailand. The antenna has been designed to withstand typhoon winds of up to 210 mph when it is locked into "stow" position and pointing vertically upwards.

● A second earth station is being built to face west and eventually add New Zealand, Viet-nam and South Korea to the list of lands to be linked with the famous colony. ■



Hong Kong Issue



China (Taiwan) Issue



Rep. of Argentina
20 & 40 Peso Issues





BOOKMARK BY BOOKWORM

Some Buy! It's only 50¢ and the best buy in town! Ameco's *License Guide* by Martin Schwartz is a Radio Amateur's question and answer course that every aspiring ham should own and read. Updated to include the latest FCC rule changes, this guide actually offers the questions with multiple choice answers you may



Soft cover
48 pages
50¢

see on your amateur radio exam. The *License Guide* is the next best thing to a crib sheet in the exam room. The Guide is divided into four major sections. They are: Novice class questions and answers; General class questions and answers; FCC-type Novice examination, and FCC-type General examination. Answers to the examination are given in back of the Guide. Most stores and mail order houses that sell amateur equipment also sell Ameco's *License Guide*. Can't find a copy, then write to Ameco Publishing Corp., 314 Hillside Ave., Williston Park, N. Y. 11596.

FM Theory. The fidelity and noise-free qualities of FM reception are known and enjoyed by many; just how these qualities are achieved, the principles and circuitry of FM broadcasting and



Soft cover
159 pages
\$3.95

reception, are less well known. *FM From Antenna to Audio* by Leonard Feldman presents a complete description of FM reception, with special emphasis on FM principles and receiver circuitry.

If co-channel and adjacent-channel interference and pre-emphasis and de-emphasis are unknown terms to you, don't despair. The author devotes two chapters in the laying of ground work before he takes up the receiving system. At the end the author dwells on FM receiver alignment and measurements.

In this concisely written book, the author presents a complete picture of FM reception and FM receivers, from basic principles to latest developments in AFC and tuning aids. To get your copy, write to Howard W. Sams & Co., Inc., Indianapolis, Indiana 46206.

1 + 1 is 10. *Electronic Switching Circuits (Boolean Algebra and Mapping)* by Matthew Mandl is an up-to-date explanation of the basic principles of electronic switching that is presented for the first time at the technical-institute level. The text explains logic circuits using dia-

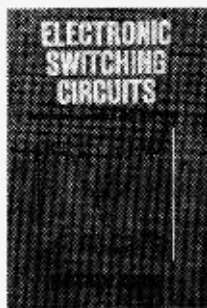

Cloth bound
229 pages
\$12.50

grams, logic maps, and truth tables, and discusses parallel methods in detail with Karnaugh maps and Venn diagrams. This book is for the serious experimenter who plans a career in computer electronics. Pick up a copy at any bookstore or direct from Prentice-Hall, Inc., Englewood, N. J. 07632. ■

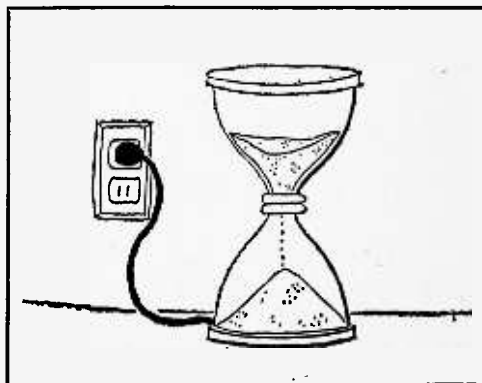

**KEEP
UP TO DATE.
WITH
SCIENCE &
MECHANICS**

Science & Mechanics—
the only magazine
that keeps you right
up to date on de-
velopments in
space technology,
weapons, auto-
mobiles, medicine,
boats, planes,
tools, new prod-
ucts, and exciting
world events.

Keep up to date.
Make sure of your
home delivered
copy by returning
the coupon today.



SCIENCE & MECHANICS, Dept. 279
229 Park Ave., S., New York, N.Y. 10003

Yes! Please enter my subscription for one year
for only \$2.98 (regular price \$4) (foreign add; \$1).

I enclose \$..... Bill me

Name _____ (Please Print)

Address _____

City _____ State & Zip _____

The Skies Above Us

by Dr. Roy K. Marshall

☆☆ Here is the summer sky at its best, with Vega its brightest gem almost exactly in the zenith in the August map. Deep orange Arcturus, about as bright as Vega, is still up in the west; undeniably red Antares, about half as bright as Arcturus, stands lower in the south-west.

☆ Vega is the western corner of "the Summer Triangle," with Altair in the constellation Aquila, the Eagle, and Deneb ("the Tail") of the Swan, Cygnus, the other two corners. While Cygnus is classically the Swan, we all feel compelled to call the figure the "Northern Cross," because it looks like a cross (could there be a better reason?), which the better-known Southern Cross certainly doesn't. The latter is too far south to be visible except at very critical times, and then only from the utmost southern tips of continental U.S.A. Our 50th state, Hawaii, is more favored, if that is the word.

☆ Sagittarius, the Centaur-Archer, looks like a teapot in the south, Capricornus, the Sea-Goat (front part goat, with a fish's tail) like a triangle with distorted sides, but Scorpius looks like a pretty good Scorpion, with its curled-up tail and all. If you look at it later (or on the September map) you will see the Teapot seemingly tilted up so it is in position to pour hot tea on the tail of the scorpion. No wonder it's curled up!

☆☆ Another August event, this time an annual, is the meteor shower called by the Irish peasants, in older times, "Tears of St. Lawrence," for the man considered very responsible in the conversion of Rome; he was martyred in 282 A.D. His feast day is Aug. 10, but his "tears" appear in maximum numbers about Aug. 12. In 1970, I have calculated the maximum for August 12 at about noon, Eastern Daylight Time, a time of day when "shooting stars" are normally not visible, so consider the

(Continued on page 20)

THE AMAZING WORLD OF SOUND

ASTRO-COM TELEPHONE-AMPLIFIER

Transforms any ordinary telephone earpiece into a unique sound-control amplifier! It's a space-age electronic concept that assures the maximum in hearing range and comfort... attaches instantly and securely to any phone with a simple, snug-fitting band. Carry it in your pocket... or in purse, it's that portable! Especially suited for high-noise factory and office areas. And, it's a low-cost practical answer to public phone distractions. What's more, the hard-of-hearing, and elderly folks find it a definite aid, while guaranteeing privacy!

Precision-built for reliable performance, the ASTRO-COM amplifies any normal speaking voice up to five times. Complete with easily adjustable fingertip touch volume control.



Amplification: More Specification than 30db
Circuitry: 4 transistors
Case: High Impact Polystyrene
Battery: For best results, use Saxton #B-103 battery or equivalent. Battery life expectancy—25 hours.

only \$995
 (less battery)

"SKY-SPY" NOW!! Add A New Dimension To Listening... Up!

Complete SKY-SPY only \$1695
 (less batteries)



Amazing... excitingly new! "SKY-SPY" allows reception from planes within a range of 75 miles; even permits reception from the aircraft tower itself within a 15 mile range.

Hear how aircraft are instructed to land, weather conditions, delays in landings, etc....

This unique device uses 1.52 hearing aid batteries... giving it a 65 hour life span.

ASTRO-COM WRIST RADIO Transmitter

- Broadcasts your voice to any FM receiver within 50 feet in any direction.
- No wires! Powerful tiny silver oxide battery good for hours of broadcasting!
- Great for party fun; kids' games; keeps you in touch with playroom, bedroom, or sick room.
- Complete with replaceable silver oxide battery, nylon strap, rugged case, "whip" antenna, and tuning device.
- Electronic components designed by Saxton first in miniature electronic equipment.

SPECIFICATIONS: Frequency Response: 300 to 6,000 Hz.; POWER: 6 MW input; RANGE: Up to 50 feet, depending upon conditions; Frequency: FM broadcast band, (tunable ± 3 megacycles through 88 megacycles); Audio Sensitivity: Normal voice at approximately 10 feet; Case: High impact polystyrene-electronics encapsulated in epoxy; Weight: 4 ozs.

SPECIAL INTRODUCTORY PRICE ONLY \$1400

THE BIG EAR

"HOMES IN" on faint sounds up to 100 feet away... twice as far over water.

- Exclusive cordless Broadcast Accessory also available—Increase sensibility tenfold.
- USE INDOORS OR OUTDOORS— from baby sitting to bird watching.
 - ENTERTAINING, PRACTICAL AND IN-STRUCTURAL for young and old.
 - THE LATEST IMPALID STATE CIRCUITRY.
 - PROTECTIVE DEVICES to listen for intruders at night.

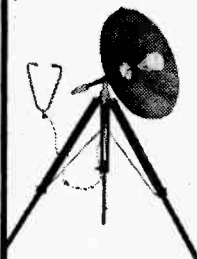

The "BIG EAR" is an amazing electronic device which is completely portable. Basically it combines the principle of a parabolic microphone, a high gain amplification system and stethoscope earphone for intimate listening.

The "BIG EAR" comes complete with its own sturdy adjustable tripod base for convenient use anywhere... operates for hours on standard 9 volt-transistor battery.

Complete with Stethoscope \$1995 earphones ONLY (less batteries)

BIG EAR BROADCAST ACCESSORY

Plug in our exclusive cordless Broadcast Accessory and convert Big Ear into a group entertainment listening device. The "Big Ear Broadcaster" let you broadcast sound to any FM receiver up to 30 feet away. With it you hear everything, without connecting wires with 30 times amplification.

Stay indoors and listen to bird calls and animal sounds. Place it in a baby's room or near the baby carriage or use it as a sick room monitor.



BROADCASTER COMPLETE ONLY \$1495 (less batteries)

EYEGGLASS RADIO



Clips to your glasses, receives the whole AM broadcast band, can be used wherever you go "cause it weighs a few ounces. Comes with earphone plug for privacy, convenient on-off and tuning knobs. Includes 1.5v. hearing aid batteries for many long hours of listening pleasure.

only \$1595

D & D SALES CO. DEPT. WS-8
 60 E. 42nd Street
 New York, N.Y. 10017

Please send me the following items on a full money back GUARANTEE, if I'm not completely satisfied.
 I enclose my check (or money order) for \$ _____

ITEM	NUMBER OF UNITS	UNIT PRICE	TOTAL PRICE
BIG EAR		\$19.95	\$
BROADCASTER		14.95	
PHONE AMPLIFIER		9.95	
SKY-SPY		16.95	
WRIST RADIO		14.00	
EYE GLASS RADIO		15.95	

Plus Postage & Handling 1.50 per unit

New York State Residents add appropriate tax

TOTAL AMOUNT ENCLOSED

THE SKIES ABOVE US

nights of August 11 and 12 as sharing the maximum.

☆ Meteor showers occur as the earth passes through a swarm of tiny objects traveling along like an elongated cloud, pursuing an orbit around the sun. The path followed by these August meteors is the same as that of the comet discovered in 1862 by Lewis Swift, which is expected to return in about 1984, but the meteors appear every year, having been observed as early as in 900 A.D., so they must be strewn along the path of the comet from which they may have leaked.

☆ Officially, they are called Perseids, because they seem to radiate from the constellation Perseus, low in the northeastern September map. Most meteors will be seen if the observer looks in that direction, but many will be seen in other parts of the sky. Save some late-evening or after-midnight hours for meteors, between Aug. 9 and 14, even if the moon will cut down the optimum rate of about 60 per hour.

☆☆ On the evening of August 16, a full moon occurs, but a close watcher will see a smudge deepening at the upper left edge, about 8:15 p.m. and at last, at 9:18, a definite nick will begin, and grow as the moon goes into partial eclipse near the eastern corner of Capricornus. Maximum eclipse, with 41% of the moon's diameter immersed in the earth's shadow, occurs at 10:24 and the important part of the show ends at 11:30, although the "smudge" continues for about an hour. The diagram tells more of the story.

☆ An annular eclipse of the sun, like a total, but with the moon not quite able to cover all

of the sun, thus leaving an annulus or ring of the sun around the black lunar disk, will occur on August 31, but forget it, unless you plan to be in the South Pacific in some part of a narrow path from New Britain through Melanesia almost to the point where Antarctica reaches out toward the tip of South America.

☆ To return to the August 16 lunar eclipse, the moon will rise at about sunset for everyone on earth on that date, because the full moon occurs then, when the moon is exactly opposite the sun. But only those who live where the moon is in their sky from 9:18 to 11:30 p.m., E.S.T. (which will be 10:18 p.m. Aug. 16 to 12:30 a.m., Aug. 17, Eastern Daylight Time, for most of us) will be able to see all of the important part of the eclipse—the passage of the northern 41% of the moon's diameter through the umbral shadow of the earth.

☆ Unless only a bright point of light is the source, the shadow of any object will have a dark core and a tapering-off border. The part of the shadow that gets no light at all from a larger-than-a-simple-point source is called the *umbra*, the Latin word for "shadow;" the falling-off outer border surrounding the umbra is called the *penumbra*, Latin for "next to the shadow." Some light gets into the penumbra from the edges of the source when it is larger than a very small area, such as a tiny arc at a considerable distance.

☆ So the sun, a source about a half-degree wide as seen from earth (a copper cent at seven feet), by no means a point, is able to produce

(Continued on page 22)

☆☆☆ The maps show the principal stars which are above the horizon at latitude 34° North at about 9 p.m. standard time at the middle of the month. These maps are practical star location guides anywhere in the United States throughout the month showing the sky at 10 p.m. on the first and at 8 p.m. on the last of the month. To look at the night sky in June and July, select the proper map and hold it vertically. Then turn the map so that the point of the compass toward which you are facing shows at the bottom of the map. ☆☆☆ Our special thanks go to the Griffith Observatory in Los Angeles, California. ☆☆☆

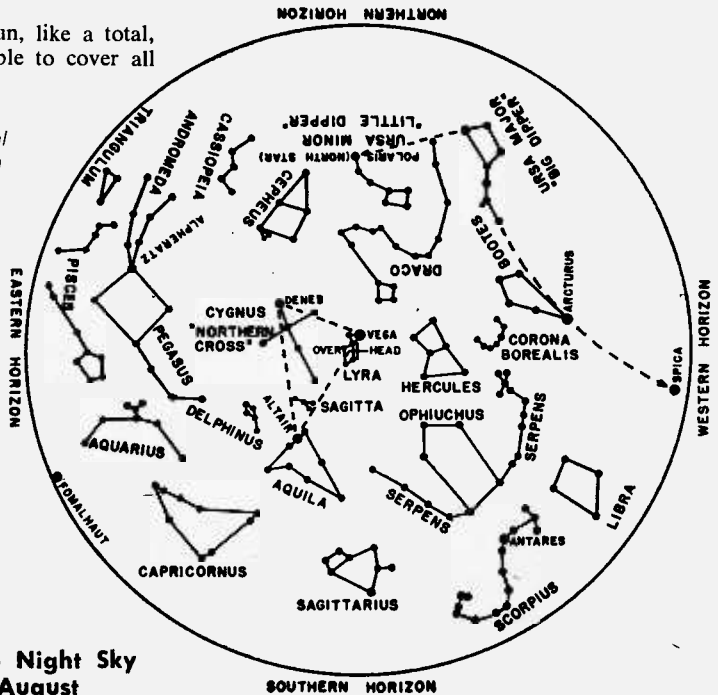

The Night Sky in August

ANNOUNCING-

Practical Handyman's Gigantic

\$99,500 GIVEAWAY

for budget-wise men and women who want to save extra \$\$\$\$ with exciting "DO-IT-YOURSELF" home projects!

Mail Claim Check Coupon below to get your share of Practical Handyman's \$99,500 Giveaway! Yes, if you want to cut costly home repair bills, increase the beauty and value of your home—**YOU HAVE HIT THE JACKPOT!** During the next few months 35,000 copies of Volume One of the **PRACTICAL HANDYMAN'S ENCYCLOPEDIA** (a whopping \$99,500 value) will be given away to readers of this publication and other home handymen and their wives **ABSOLUTELY FREE!**

MAIL the CLAIM CHECK COUPON for your share of GIGANTIC \$99,500 GIVEAWAY! Yes, take FREE everything you want to know about every money-saving home handyman project!

SEND FOR YOUR FREE VOLUME

...with more than 200 giant 7 3/4" x 10 1/4" pages, filled to overflowing with more than 400 "how to" pictures and projects!

SEND FOR YOUR FREE VOLUME

...packed with interesting "do-it-yourself" projects such as Built-In-Closets and Drawers—Auto Tune-Ups—Air Conditioning of Home and Car—TV Adjustments—Motor Repairing—Attic Ventilation—Aluminum Projects—Garden Accessories—and many, many more.

SEND FOR YOUR FREE VOLUME

...find such "money-in-your-pocket" projects as: Appliance Repairs—TV Antennas—Emergency Car Repairs—Spray Painting—Burglar Alarms—Additional Bedrooms—Boosting Gas Mileage—and many, many more!

IDEA: Add an extra bedroom virtually for cost of materials alone. Save up to \$1,000.



SEND FOR YOUR FREE VOLUME

...discover the pleasure and sense of accomplishment in such projects as: Home Ventilation—House Framing—Window Framing—Skylights—Barbecues—Weatherproofing—and many, many more!

THOUSANDS OF DOLLARS WORTH OF EXPERT ADVICE

There is no obligation! We give you this valuable FREE VOLUME so that you may see—at our expense—just how valuable the PRACTICAL HANDYMAN'S ENCYCLOPEDIA can be for you and every member of your family! 22 Superb Volumes! 4,056 fact-filled pages. Over 7,250 Show-How Pictures! Over 1,000,000 Instructive Words! Hundreds of Expert Contributors—Thousands of Pleasure-Giving Ideas and Projects! Alphabetically Arranged! Complete Cross-Reference Index!

NOW YOU CAN SAVE \$\$\$\$ BY DOING IT YOURSELF!

Think of it! You can SAVE \$325 on a cedar closet—SAVE over \$1,000 by building your own garage—SAVE up to \$100 by covering your backyard patio yourself—SAVE \$50 by installing acoustical tile on playroom ceiling—SAVE \$60 by paneling a room yourself—SAVE up to \$2,000 by constructing your own vacation cabin!

18 ENCYCLOPEDIAS IN ONE HANDYMAN'S LIBRARY

Here's an Encyclopedia that thoroughly covers just about EVERY kind of Home Repair

IDEA: Build this outdoor grill! Enjoy 1,001 other money-saving projects!

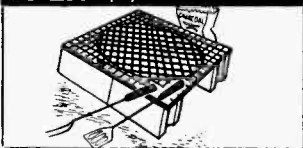

and Improvement, including: Carpentry, Plumbing, Electrical Wiring, Appliance Repair, Masonry and Cement Work, Painting, Flooring, Upholstery, Roofing, AND IT IS ...

ALSO AN ENCYCLOPEDIA OF GARDENING with hundreds of pages on Home Landscaping, Making a Perfect Lawn, Flower Raising, Roses, Cold Frames, Garden Furniture, Arbors, Walks!

ALSO AN ENCYCLOPEDIA OF FURNITURE MAKING, including hundreds of handsome Chairs, Closets, Sofas, Beds, Desks, Tables—for Living Room, Bedroom, Nursery, Playroom, Den, Library, Patio—for every room in your house or apartment!

ALSO A HI-FI, STEREO, AND TV ENCYCLOPEDIA, including Assembling Systems, Equipment Improvement, Tape Recorders, Picture-Tube Installations, Trouble-Shooting and Repairs!

ALSO A TOYS-AND-GIFTS ENCYCLOPEDIA, with complete illustrated instructions for Swings, Happy Clown Slide, Circus Wagon, Teen-Age Hi-Fi, etc.

ALSO A CAR OWNERS ENCYCLOPEDIA, covering Engines, Brakes, Fuel, Ignition and Cooling Systems, Trouble-Shooting, Emergency Repairs, Building a Midget Auto, a Hot-Rod, a Go-Cart!

ALSO A WORKSHOP ENCYCLOPEDIA, covering all types of Power Tools, Hand Tools, Work Benches, Building and Equipping Workshops! PLUS... 12 others!

FOOL PROOF STEP-BY-STEP DIRECTIONS THAT CAN'T FAIL!

Here is a partial list of the foremost experts who created the "Can't-go-wrong" projects: Bernard Gladstone, Home Improvement Editor, New York Times; Walter Fischman, "how-to" writer, New York News and Popular Science; Robert Hertzberg, famed electronics expert; Art Margolis, who conducts TV Repair Department of Popular Science; Fred Russell, dean of car experts—and hundreds of others!

CLAIM YOUR SHARE OF \$99,500 GIVEAWAY—GIANT VOLUME ONE FREE—YOU RISK NOTHING!

Mail the CLAIM CHECK COUPON below today! Volume One of the PRACTICAL HANDYMAN'S ENCYCLOPEDIA will be sent absolutely FREE! You do not have to subscribe to anything in order to get this book.

But you may if you wish, go on to accumulate further volumes of this Encyclopedia.

Each big, new volume will come to you ENTIRELY ON APPROVAL for 7 days' FREE EXAMINATION.

Volumes 2, 3 and 4 will come to you about one a month. After that, remaining volumes

will come in two shipments...all ON APPROVAL. Within 7 days' FREE EXAMINATION you may decide whether to keep the shipment or not—you may decide to return it and owe nothing, or you may remit the low price of just \$3.49 per volume plus a few cents for shipping—for only one book each month. You may buy as few volumes as you wish, even none at all if you so choose, and no volumes will be sent after your cancellation is received.



MAIL CLAIM CHECK COUPON BELOW TO CLAIM YOUR SHARE OF \$99,500 GIVEAWAY!

CLAIM CHECK B986-V

\$99,500 Giveaway
Handyman's Encyclopedia
Science & Mechanics Co.
229 Park Avenue South
New York, N. Y. 10003

YES! Here is my Claim Check coupon. Please rush me my share of your big \$99,500.00 GIVEAWAY — my big, exciting, colorful Volume One of THE PRACTICAL HANDYMAN'S ENCYCLOPEDIA to be mine forever ENTIRELY FREE, without charge of any kind, and additional volumes on your FREE-TRIAL shipment plan (as outlined above) at the low price of \$3.49 each plus shipping.

If I am not delighted I may return my shipment within 7 days and owe nothing for it. I may STOP AT ANY TIME, and you will send me no more volumes after receiving my order to STOP.

Name _____
Address _____
City _____
State _____ Zip Code _____

THE SKIES ABOVE US

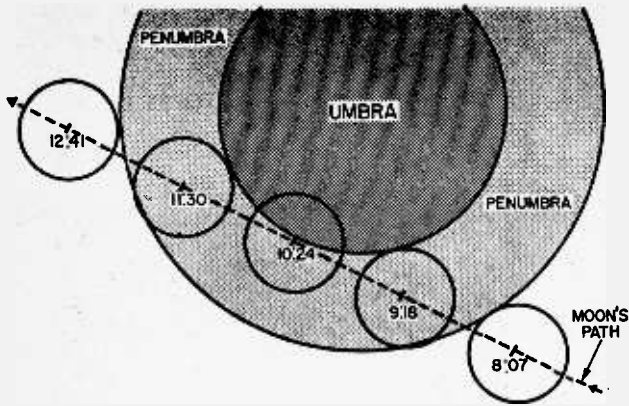

In this diagram of the passage of the moon through the earth's shadow, producing the partial lunar eclipse on the evening of Aug. 16, 1970, the times are E.S.T., so they must be increased by one hour for Eastern Daylight, taken as they are for Central Daylight, diminished by one hour for Mountain Daylight and by two hours for Pacific Daylight Time. The moon's three middle representations indicate the portion of the eclipse that will be obvious. North is at the top.

a shadow of the earth that has an umbra and a penumbra. At the very outer edge of the penumbra, the full sunlight is shining; as we go in farther, less and less of the full disk of the sun is exposed, so the penumbra deepens until, at last, the moon enters the umbra.

☆ But the earth's atmosphere bends some sunlight into the umbra, so it also deepens toward its center and we can expect the "bite" in the edge of the moon to be darker, farther from the moon's center, at mid-eclipse. Because the long red wavelengths of sunlight get through our air more plentifully than others as it is refracted, the umbra appears reddish, from bright bronze to dull old copper or even, if there is a lot of cloudiness around the rim of the earth, very, very dark. There have been instances when, because of extreme cloudiness or, more significantly, when violent volcanic explosions have loaded the high atmosphere with dust, a totally eclipsed moon has been visible only with difficulty.

☆ With new high-speed color films (Ansochrome 500, for example), color photographs are now easier, provided the focal length of the lens of the camera is great enough. The moon looks big in the sky, but it will be an insignificant little spot on the film exposed in an ordinary camera, so don't waste the film.

☆ At the mean distance of 238,855 miles, the moon's diameter on a film is given by dividing the focal length of the lens by 110. A common focal

length for what is called a 35 mm. camera is two inches, so the moon's image diameter will be a little less than one fiftieth of an inch. So get a long lens, if you're not set up to attach a camera body with the film in the focal plane of a telescope lens or mirror. I use a 16-inch telephoto lens on my camera and get an image about one-sixth inch in diameter that is worth enlarging.

☆ Use exposures of 1/50 to 1/25 second, at f/8 or f/11, where most lenses perform best, on film with ASA speeds of 100 to 500. Take a lot of exposures—film is the cheapest ingredient—at various speeds and openings, and I hope you get at least a few very good ones. Lots of luck! ■

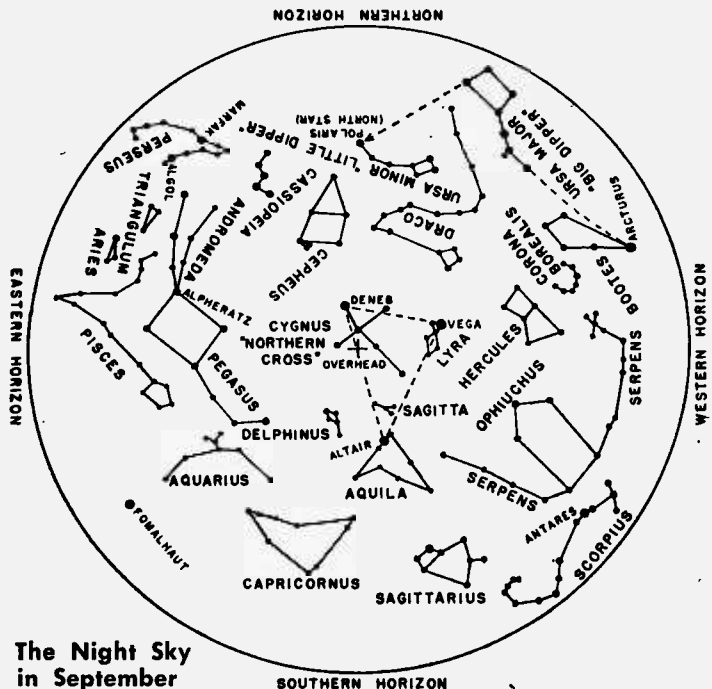

The Night Sky in September

SOUTHERN HORIZON

NORTHERN HORIZON

EASTERN HORIZON

WESTERN HORIZON

LITERATURE LIBRARY



1. *Allied's* catalog is so widely used as a reference book that it's regarded as a standard. The surprising thing is that it's free!
2. Now, get the all-new 512-page, fully illustrated *Lafayette Radio 1970* catalog for CB gear, test equipment, ham gear, tools, books, hi-fi components, etc.
3. Get all the facts on *Progressive Edu-Kits Home Radio Course*. Build 20 radios and electronic circuits; parts, tools and instructions included.
4. *Olson's* catalog is a multi-colored newspaper that's packed with more bargains than a phone book has names.
5. *Edmund Scientific's* new catalog contains over 4000 products that embrace many interests and fields.
6. Bargains galore, that's what's in store! *Poly-Paks Co.* will send you their latest 8-page flyer.
7. Before you build from scratch, check the *Fair Radio Sales* latest catalog for surplus gear.
8. Get it now! *John Meshna, Jr.'s* new 96-page catalog is jam packed with surplus buys.
9. Troubleshooting without test gear? Get with it—let *Accurate Instrument* clue you in on some great buys.
10. *Burstein-Applebee* offers a new giant catalog containing 100s of big pages crammed with savings.
11. Now available from *EDI (Electronic Distributors, Inc.)*: a catalog containing hundreds of electronic items.
12. *C. B. Hanson's* new Automatic Control records both sides of a telephone call automatically.
13. Discover how to drive nuts and screws, ream, scribe, pierce holes with *Xcelite's* Series 99 handles and interchangeable blades.
15. *Custom Alarms* reveals how inexpensive professional alarms can really be. Circle 15 for exclusive catalog.
18. Here's a free 20-page booklet that tells you how to improve your TV pic and a do-it-yourself approach to installing a Master Antenna TV (MATV) system. *Mosley Electronics* will wing it your way.
19. *RCA Experimenter's Kits* for hobbyists, hams, technicians and students are the answer for successful and enjoyable projects.
20. Get your copy of *E. F. Johnson's* new booklet, "Can Johnson 2-way Radio Help Me?"
22. Kit builder? Like wired products? *EICO's* 1970 catalog takes care of both breeds of buyers.
23. No electronics bargain hunter should be caught without the 1970 copy of *Radio Shack's* catalog.
26. Get with 1970's hi-fi jet set. *H. H. Scott* sets the pace with their fantastic line of audio components, some in kit form too!
42. *Heath's* new 1970 full-color catalog is a shopper's dream. Its 116 pages are chuck full of gadgets and goodies everyone would want to own.
45. *CBers, Hams, SWLs*—get your copy of *World Radio Labs' 1970* catalog. Circle 45 now!
48. *Hy-Gain's* new CB antenna catalog is packed full of useful information. Get a copy.
74. Get two free books—"How to Get a Commercial FCC License" and "How to Succeed in Electronics"—from *Cleveland Institute of Electronics*.
100. You can get increased CB range and clarity using *B&K's* hot "Cobra" transceivers.
107. Want a deluxe CB base station? Then get the specs on *Tram's* super CB rigs.
111. Get the scoop on *Versa-Tronics' Versa-Tenna* with instant magnetic mounting.
114. Prepare for tomorrow by studying at home with *Technical Training International*. Get the facts on how you can step up in your present job.
116. Pep-up your CB rig's performance with *Turner's M+2* mobile microphone.
127. *National Schools* will help you learn all about color TV as you assemble their 25-in. color TV kit.
130. Bone up on CB with the latest *Sams* books. Titles range from "ABC's of CB Radio" to "99 Ways to Improve your CB Radio."
136. You can become an electrical engineer only if you take the first step. Let *ICS* send you their free illustrated catalog describing 17 special programs.
137. For success in communications, broadcasting and electronics get *First Class FCC* license. *Grantham School of Electronics* will show you how.
140. Take a gander at *Cornell Electronics' latest* catalog. It's packed with bargains like 6W4, 12AX7, 5U4, etc., tubes for only 33¢.
141. CB antenna catalog by *Antenna Specialists* makes the pickin' easy.

SCIENCE AND ELECTRONICS

Dept. 970

229 Park Avenue South
New York, N.Y. 10003

Please arrange to have this literature whose numbers I have circled at right sent to me as soon as possible. I am enclosing 25¢ to cover handling. (No stamps, please.)



1	2	3	4	5	6	7	8	9	10
11	12	13	15	18	19	20	22	23	26
42	45	48	74	100	107	111	114	116	127
130	136	137	140	141					

Indicate total number of booklets requested
Sorry, only 20 circled items maximum.

NAME _____

ADDRESS _____

CITY _____

STATE _____ ZIP _____

IN THE HEAT OF THE NIGHT

by Jack Schmidt

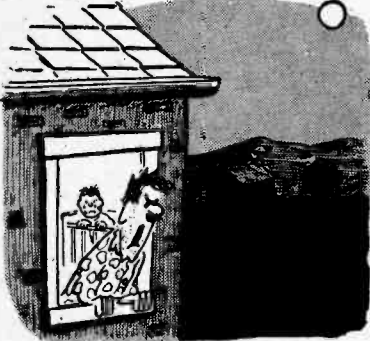

"Watch that feedback!"

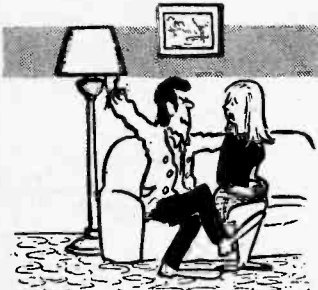

"Don't try, Harold. The room is full of electronic sensors!"



"About now, Arnold, we should be getting some sort of answer!"

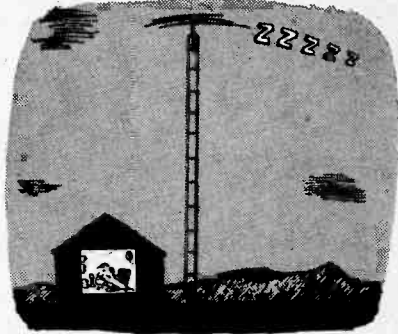

"... 15 transistors, 7 diodes, variable squelch, double-sideband ..."



"Can the kids and I sleep here? It's the only cool room in the house!"

Measure
both polarity
and intensity

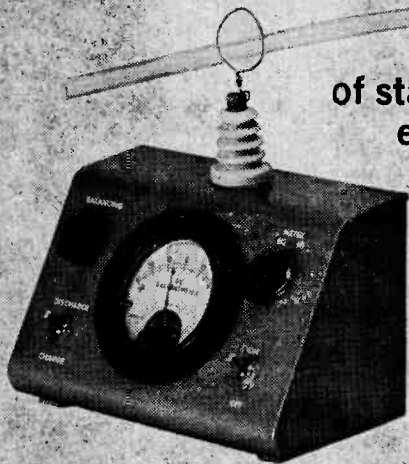

of static
electricity
with our
modern
IC electroscope

by George Mulfinger
W4CNR

The Electro-Snoop is a modern, accurate, and reliable instrument for measuring static electricity. It is designed to measure both the polarity and intensity of static charges. The Electro-Snoop is a modern, accurate, and reliable instrument for measuring static electricity. It is designed to measure both the polarity and intensity of static charges.

The author found the instrument extremely useful around a physics laboratory. On one occasion it was desired to know the polarity of the discs of a newly constructed Van de Graaff generator. The Electro-Snoop was placed about eight feet from the generator. The generator and Electro-Snoop were both turned on and the meter went off-scale to the right, indicating a strong positive charge. This proved that electrons were being removed from the discs, as had been desired.

Electro-Snoop's Advantages. The old gold leaf

Electro-Snoop

electroscope has its problems. The gold leaves are hard to maintain and the instrument can't distinguish directly between a plus and minus charge. The Braun electro-scope represents a considerable improvement over this, but still requires an external neon lamp to determine polarity. Vacuum-tube electroscopes work nicely for negative charges, but a positive charge placed on the grid is quickly neutralized by electrons from the filament. This problem is completely circumvented by the use of a field effect transistor (FET). The absence of a filament coupled with its extremely high input impedance allows a charge of either polarity to remain undisturbed on the gate (g) while the meter is being read.

The unit forms a neat self-contained package—no external connections or power source are needed, and it can be used anywhere, indoors or out. Battery drain is quite low, less than 1 mA when the bridge is balanced. It increases to something better than 1 mA with a positive charge and drops to

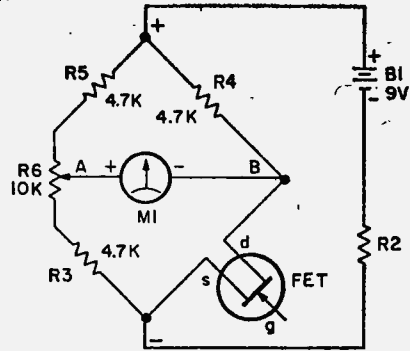

Redrawn Electro-Snoop shows Wheatstone Bridge formed by resistors R3-R5, pot R6, and FET.

½ mA or even less with a negative charge. **How Electro-Snoop Works.** We've redrawn the heart of *Electro-Snoop's* circuit into a conventional Wheatstone Bridge configuration, as shown in our simplified circuit drawing. From this it can be seen that current flows in two separate paths. Using the negative input at the bottom of the diagram as a starting point, it can be seen that electrons may travel up the left side through resistors R3, R6, and R5 to the positive, or up the right side through the FET and R4, and

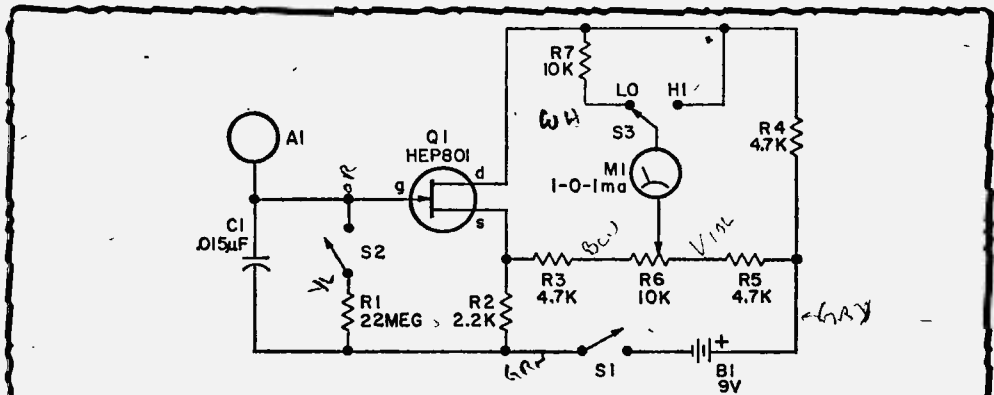

PARTS LIST FOR ELECTRO-SNOOP

- A1—Wire loop antenna, made from #16 bare copper wire, loop 1½-in. diam.
- B1—9 volt transistor radio battery (Burgess 2U6 or Eveready 216, or equiv.)
- C1—0.015 uF, 600 volt tubular capacitor (Lafayette 34E82536 or equiv.)
- M1—1-0-1 DC galvanometer Weston model 375 or equiv.)
- Q1—Field effect transistor, Motorola HEP801
- R1—22-megohm, ½-w resistor
- R2—2200-ohm, ½-w resistor
- R3, R4, R5—4700-ohm, ½-w resistor
- R6—10,000-ohm, linear-taper potentiometer, Lafayette 33E11255 or equiv.)
- R7—10,000-ohm, ½-w resistor
- S1, S2—Spst toggle switch (Lafayette 34E33026 or equiv.)

- S3—Single pole, two position rotary switch (Lafayette 30E49202 or equiv.)
- 1—Battery connector (Lafayette 99E62879 or equiv.)
- 1—Battery holder (Keystone 203P or equiv.)
- 1—Porcelain stand-off feedthrough insulator (Lafayette 33E32012 or equiv.)
- 1—7 X 4 X 4¼-in. utility cabinet (Bud AC1613 or equiv.)
- OPTIONAL (see text)
- 1—Transistor socket and mounting ring (Lafayette 32E42195 & 32E42260 ring or equiv.)
- 1—4¾ X 4 X 4¼-in. universal meter case (Lafayette 12E83175 or equiv.)
- MISC.—Perf board, push-in pins (Lafayette 19E83022 or equiv.), rubber feet knobs, wire solder, spacers, bolts, nuts, etc.

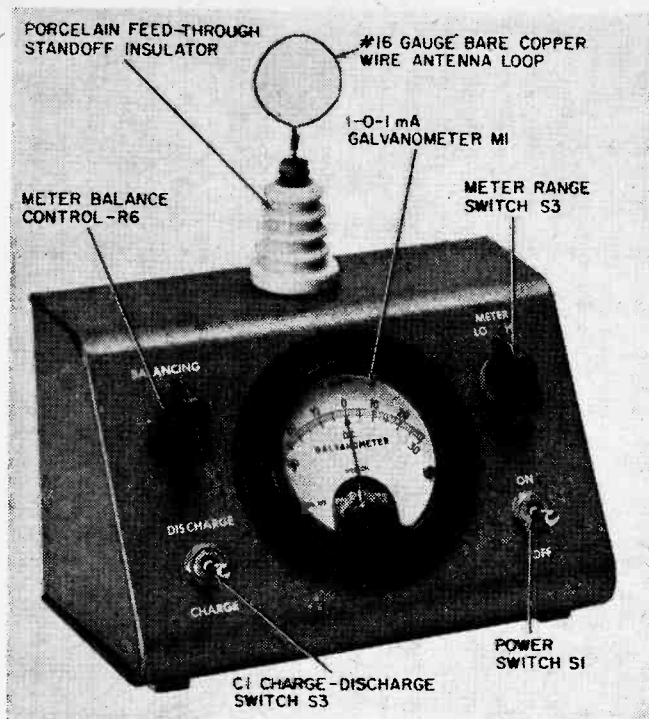

Don't like antenna loop topside?
Metal foil square also works.

point A. Again, because there is a difference in potential, current will flow through the meter, this time deflecting the pointer to the right. By using a value for R2 specified in the Parts List there will be latitude for good deflection in both directions.

Referring back to *Electro-Snoops's* complete schematic, it will be noted that a capacitor (C1) and a resistor (R1) are in the input circuit. When S2 is closed (*Discharge* position) these form a DC RC circuit having a time constant of about $\frac{1}{3}$ second. This provides sufficient time for the meter to be read when a

meet at the positive pole at the top of the diagram.

The purpose of R2 is to limit the voltage on the FET to approximately 2V. By adjusting R6 a balance position can be found at which points A and B in the diagram are both at the same potential, approximately 6.5V. Therefore, since there is no potential difference across the meter, it will read zero. In this balanced state, whenever a charge is placed on the gate of the FET, the bridge will respond, with the meter swinging either to the right or left depending on the polarity of the charge.

Whenever a negative charge is placed on the gate of the FET, electrons will be inhibited from passing through the FET. This in effect is equivalent to raising the resistance in this arm of the bridge, which, in turn, increases the voltage drop across the FET proportionally. Point B now assumes a higher potential than point A, and since there now is a difference in potential across the meter, current flows through the meter, deflecting the pointer to the left.

When a positive charge is placed on the gate, electrons will flow more easily through the FET, thus in effect lowering its resistance. The voltage now divides between R4 and the FET in such a manner that the voltage of point B is lowered with respect to

charge is placed on the antenna of *Electro-Snoop*. The circuit then quickly returns to normal as C1 discharges through it.

Capacitor C1 also prevents the meter from oscillating unduly as a charged object is being withdrawn from the antenna loop. With S2 open (*Charge* position), C2 merely stores cumulatively whatever charges are placed on the antenna until switch S2 is again closed to discharge the capacitor through R1.

Switch S3 is a meter sensitivity switch. With S3 in the *high* sensitivity position the meter is connected directly to the bridge. When S3 is placed in the *low* sensitivity position the meter is connected in series with R7 to limit current through it.

Construction. Our model *Electro-Snoop*, shown in the photos, was housed in a 7 x 4 x $\frac{1}{4}$ -in. sloping panel utility cabinet. You'll have to punch out a big hole (size dependent on the meter you use) to mount the meter in the sloping front panel. If you don't want to work so hard punching out this hole, buy a standard sloping panel meter case. It comes with a hole ready punched for a 2-in. meter and a knockout to enlarge it to 3-in. if need be. However, it doesn't come in the 7-in. width so you'll have to use a smaller piece of perf board to mount the FET, resistors, and capacitors used in the

Electro-Snoop

circuit. Even so, this should present no hardship since they are small and don't require as much space as was actually used in the model.

If you don't want to go to the expense of a special sloping panel cabinet the unit will work just as well in any case you have available since the circuit isn't critical to parts placement beyond the normal good wiring practices.

In addition to the meter hole, two 1/2-in. holes for the toggle switches are drilled near the bottom of the sloping panel, one on either side of the meter. Another 1/2-in. hole is drilled in the top of the case for the feed-through insulator for the antenna. Two 3/8-in. holes are drilled near the top of the front panel spaced to line up with the two bottom holes, one to the right of the meter for the meter-range switch and one to the left of the meter for the balance-potentiometer. When these holes have been drilled and de-burred you are ready to mount the various components in their respective mounting holes.

The antenna is a length of #16 bare copper wire formed into a closed loop with a continuing lead-in long enough to attach it by the top nut of the feed-through insulator.

For the model in the photos we mounted

the balance of the components on a 4 1/2 x 2 1/4-in. piece of perf board. If by chance you use the smaller meter case, the perf board will, of necessity, be smaller. We used a socket to plug-in the FET. This isn't an absolute necessity, and you may want to mount all of the parts, including the FET on push-in pins (they make good supports and also make it easier to replace soldered-in parts). Should you decide to eliminate the socket for the FET, be sure to protect the FET with a heat sink, made from a small alligator clip temporarily slipped on the lead being soldered.

The perf board is fastened to the cabinet by two 6-32 machine screws and nuts. Raise the board away from the base of the case either by using 1/4-in. spacers or extra nuts on the mounting bolts to avoid possibility of shorts between the board and the case. The interconnecting leads are now wired to the proper points. Leave the leads long enough for the circuit board to be lifted out of the cabinet if the need should arise. Resistor R7 is connected directly to S3. The lead from the lower end of the feed-through insulator should be connected directly to S2 rather than to the circuit board. The battery holder is mounted near one end of the circuit board. Trim the leads from the battery connector to fit the location.

If the high cost of the galvanometer specified in the Parts List deters you from building *Electro-Snoop* we've found an inexpensive alternative instrument. Lafayette Radio offers an edgewise balance and tuning meter in which the pointer rests center scale when no current is flowing. It will swing either right or left of center, depending on the polarity of the current flow.

The sensitivity of this meter is $\pm 100 \mu\text{A}$, which is considerably more sensitive than the meter we used in the model. You should use this meter with the meter

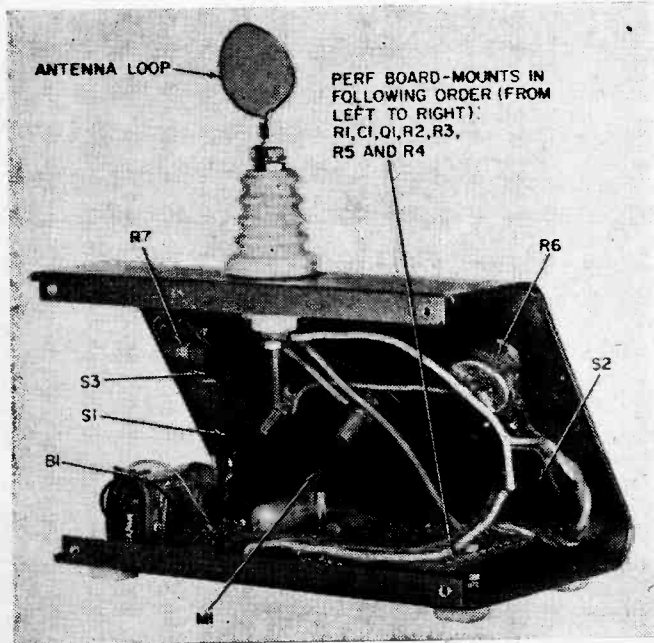

Electro-Snoop's neat innards bared to show parts placement.

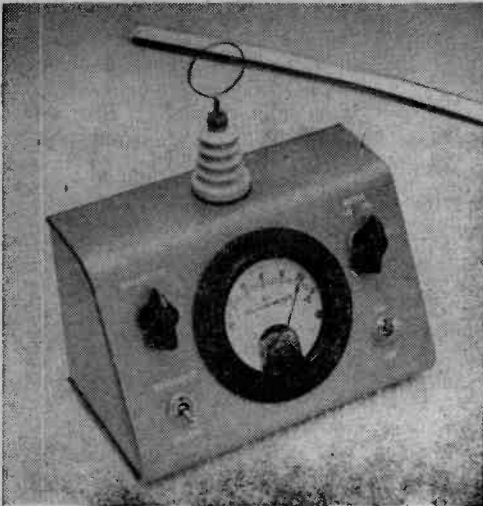

Bringing positively charged lucite rod near 'tenna loop, you'll see meter swing to right.

sensitivity switch in the *Low* sensitivity position at all times.

One point to consider: if you build *Electro-Snoop* for classroom or other large group demonstrations this alternate meter is harder to read from a distance a few feet away from the meter. Also, if you do use the alternate meter, remember not to punch the large round hole in the front panel. It mounts in a slot $1\frac{1}{16}$ -in. long by $\frac{1}{2}$ -in. high. Lafayette's part number for this tuning meter is 99E50346; it's priced at \$2.50. The meter we used, in contrast, is about \$18.00 new and about half that price used.

Calibrating and Operating. The only calibration necessary is to balance the bridge before using the instrument. With S3 in *High* sensitivity position, and S2 in the *Discharge* position, turn S1 to *on* and proceed to operate *Balance* control R6 until the meter is centered on zero. This completes the balance calibration and you're ready to experiment with *Electro-Snoop*.

A negatively charged object held near the antenna will deflect the meter pointer to the left while a positively charged object will deflect it to the right. You may hear a slight sparking sound as the charge jumps across the gap between the object and the antenna.

A negative charge can be generated by rubbing a hard rubber (ebonite) rod with wool; the minus charge appears on the rod. This is the classical method and is hard to beat. It is best to stroke the rod repeatedly in the same direction rather than rubbing back and forth. The rod is then touched to the antenna, or better still, pulled along the

antenna in order to build up the charge.

Another way of developing a negative charge is by combing the hair with a nylon comb; the nylon will acquire a fairly respectable negative charge. Still another method is walking across a thick carpet, then, when holding a finger near the antenna a spark will jump from the finger to the antenna sending the meter pointer strongly to the left.

The old textbook method of rubbing glass with silk to produce a positive charge isn't recommended. Too often only a very feeble charge will be the result. A good healthy positive charge can be generated by rubbing a lucite rod with wool or cotton. Thus the same piece of cloth can be used to develop both positive and negative charges by alternating a lucite rod (which will produce positive charges) with an ebonite rod (which will produce negative charges).

With S2 placed in the *Discharge* (closed) position, charges placed on the antenna are merely sampled and the bridge quickly returns to normal. However, with S2 in the *Charge* (open) position, charges will be accumulated on C1 and the meter reading will hold constant until the next charge is applied. Several consecutive charges of the same polarity will increase the meter reading up to a maximum high value. Then, closing S2 returns the reading to zero even though the battery is left turned *on*.

Editor's note: The author wishes to express his thanks to Bill Greaves, Chief Engineer of station WMUU, who suggested the basic idea for this project. ■

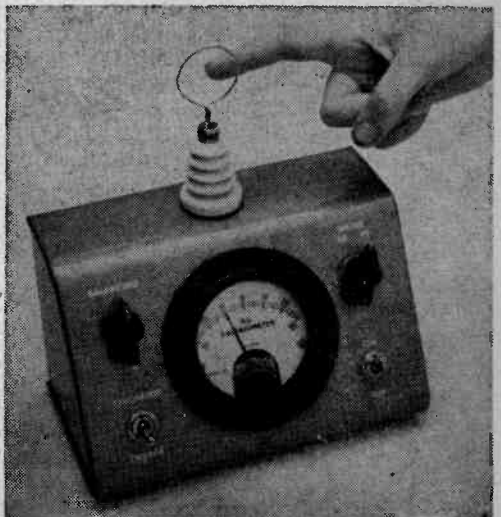

Find out what state of charge your horoscope is in. Leo's positive while Aries's negative.

Let our peeper-pleasin' wallet teaser
doll up your test gear!

NO-SQUINT

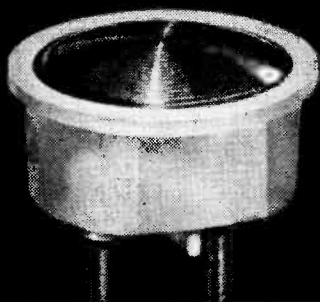

MOST of us have unintentionally allowed some test equipment to roast on our workbench overnight at some point in our electronics career. You thought the darn thing was turned *off*; a red-hot power transformer told you otherwise upon your return to the scene of the crime next day. If you're tired of searching high and low for unmistakable *power-on* indications every time you plug in line-operated equipment, then swivel your baby blues toward our *No-Squint*.

Our neon super-shiner lobs its rays at you under all indoor (or outdoor!) lighting conditions. Magnifying glasses you won't need to gaze upon this almost inch-wide pilot lamp; unlike ordinary line-operated neon indicators, this baby practically stands up and waves its orangey self at you.

No-Squint also passes the buck—back into your wallet. Four bits, give or take a few pence, entitles you to one of these 7/8-in. diameter white plastic beauties. And you can install our penny-pinching pilot light in a half hour, easily making *No-Squint* the fastest and cheapest means of protecting all of your plug-in gear from those unnecessary stew-ins.

Drill 'n' Fill. It'll take less time to mount *No-Squint* than it does to read about its virtues. Cut a 7/8-in. hole in the instrument's panel with a chassis punch. Before you actually mount *No-Squint* in this hole, squish a bead of plastic cement around the base of the hole. Press the pilot-light assembly into the hole and place some pressure on it until the glue's dry. Solder connections can be made directly to the metal prongs emerging from the business side. For safety's sake, slip a short length of spaghetti tubing over the prongs after soldering.

Plunk down 59 cents and you can pick up *No-Squint* from Lafayette Radio Electronics. They stock it under number 34E52448.

—Elmer Carlson ■

PDQ REACT-OR

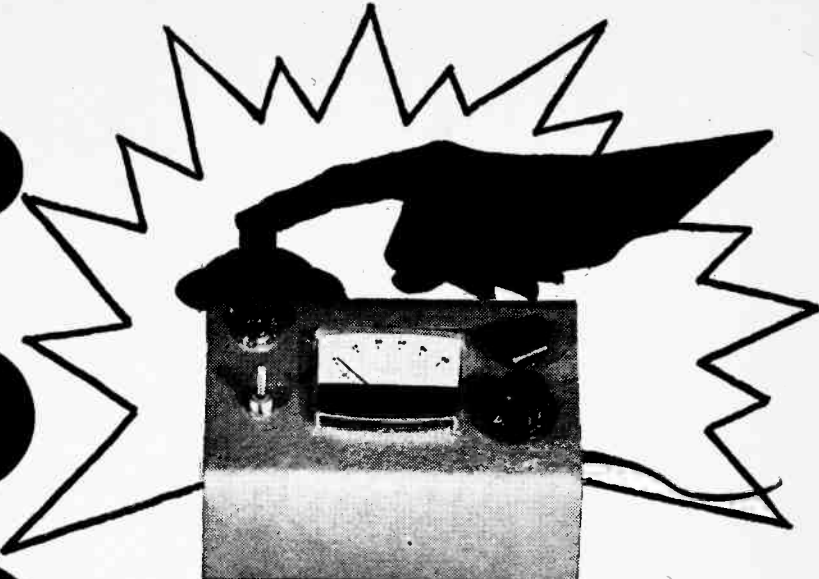

It brain-boggles while your tactiles tease it
by Stephen Daniels, WB2GIF

LIVING in the days of old Dodge City a feller had to be greased-lightning-fast with his shootin' iron. Few men dared draw against characters like Jesse James; they figured by the time their hand'd reached their holster, ol' J. James would've emptied his Colt, generally in the direction of their person.

Peculiar Twentieth Century situations involving the horseless carriage turn most mortals into modern-day Wyatt Earps. For instance, how quickly can you maneuver your Brakeless Wonder out of the path of another tired missile attempting a land speed record? Fact is, your reaction time is often your sole defense on a crowded pike. Or, driving along Main Street, U.S.A., you're confronted with a child darting unaware between parked cars in chase of an errant soft-ball. The difference between a safe child and a sorrowful driver is three-quarters of a second—your reaction time under *ideal* conditions.

Whether you drive a 3000-lb. auto or a 3-oz. golf ball, chances are your timing could stand some improvement. And better timing can be yours not by practicing on

the open road, or golf course, or even in a shooting gallery, but seated in an easy chair at home. Pretty Darn Quick is the name of our reaction-time improver. Built into a compact sloping-panel cabinet, our PDQ swiftly and accurately indicates your reaction time. It sports a novel no-cheat circuit, so you (or the person you're testing) can't run up a better score than deserved. Twenty-five clams, plus a few tin-lead acrobatics, assembles PDQ. And that should hasten your workshop reaction time!

How it Works. Take a look at our schematic of PDQ. You'll see that it's divided into four distinct sections. Let's start with unijunction transistor, Q1, and associated circuitry. This gizmo's lashed up as a relaxation oscillator; capacitor C2, resistor R2, and *Time* pot R5 determine the time interval between output pulses. In this case, the RC components selected give up a pulse every 15 to 35 seconds depending upon R5's setting. One sawtooth-shaped pulse blips out of Q1's base 1 and knocks at the gate of Q2, a silicon controlled rectifier.

Note switch S1 wired in series with SCR's anode and relay K1. It's a spring-loaded

PDQ

affair contributing to PDQ's no-cheat accuracy.

Glancing over at the third circuit section, we see that Q3, a field effect transistor, is connected along with the neighboring electron-eaters as a high-impedance voltmeter. This mini FET-VM measures the voltage in the first remaining on C3. Here's how C3 gets this voltage in the first place: when S1's held down by PDQ's operator, the SCR's anode makes connection with K1. An incoming pulse arriving from Q1 triggers off the SCR. As this happens, the relay energizes, simultaneously extinguishing lamp I1 and switching capacitor C3 to resistor R6. The combination of C3 and R6 forms a simple RC network which serves to discharge C3.

Now let's see why you need a spring-loaded switch for S1. Immediately after I1 goes out, our nimble-fingered operator lets S1 zap back to its original position; Q2's anode connection is broken with the relay, and S1 connects the FET-VM to capacitor C3. Remember, you might be faster than a speeding locomotive, but it'll take you a finite amount of time to react to I1's disappearing act. In the meantime, of course, C3 merrily discharges through R6. That's how your bullet-quick reaction time's measured. Simple, isn't it!

Now let's delve into the last circuit sec-

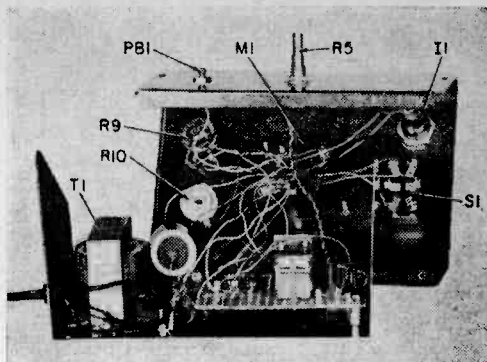

Author mounted meter M1, dpdt switch S1 on front panel of prototype reaction timer.

tion. You won't need to get hot under the collar over this conventional power supply. Consisting merely to stepdown transformer T1, encapsulated bridge rectifier Z1, filter capacitor C1, dropping resistor R1, and zener diode D1, this supply gives you oodles of room to switch n' swap your spare parts. If you've a handy 12-volt source gathering dust in the workshop, save yourself a chunk o' change by making the substitution.

Construction Capers. Start your construction efforts by wiring the power supply if you're building it in. Drill a 1/4-in. hole for the power-cord strain relief. Then ream it out slowly until the relief fits snugly. The power transformer is mounted close to the panel wall. A 6-lug terminal strip sits in front of it.

Wire T1's secondary and primary leads to the terminal strip. Note that Z1's AC side connects to the transformer's secondary leads; the positive and negative rectifier

Note author substituted two parallel 100- μ F capacitors for part C2. He also raided spare-parts box for stud-mounted 10-watt zener diode, D1. Part C2 makes connection to terminal lugs found between board, transformer T1.

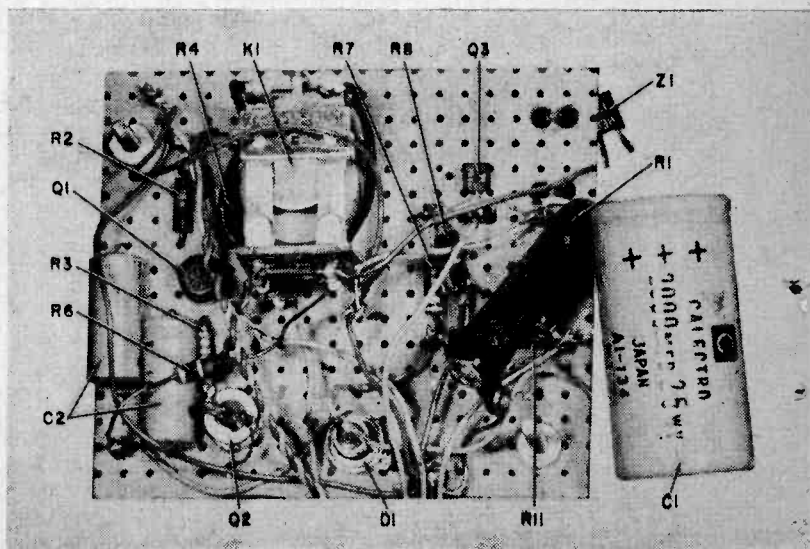

leads connect to push-in terminals conveniently located on the perf board. Solder the power-supply filter capacitor leads to the remaining terminal strip lugs, running wires from Z1 to C1's leads. Don't forget your polarity rules here; positive rectifier output terminal connects to positive filter capacitor lead.

Now solder one leg of R1 to C1's positive terminal. Resistor R1's other wire hangs fancy-free until it's eventually connected to

diode D1 and the positive power-supply bus.

Start work on the circuit board by cutting out a 3½-in. square piece of perfboard. You've scads of wiring freedom, so don't be bashful about raiding your spare-parts collection. Stick flea clips into the perf board between your point-to-point parts. After drilling a ¼-in. hole for Q2, scrounge up a solder lug for it. The lug's wedged between the SCR and perf board, so's to make con-

(Continued on page 97)

PARTS LIST FOR PDQ

- C1—2000- μ F, 25-VDC electrolytic capacitor (Cornell-Dubilier BR 2000-25 or equiv.)
- C2—200- μ F, 15-VDC electrolytic capacitor (Sprague TE 1164 or equiv.)
- C3—1- μ F, 200-VDC mylar capacitor (Cornell-Dubilier 2W1 or equiv.)
- D1—12V, 1 Watt zener diode (Motorola HEP 105 or equiv.)
- I1—NE-5 H neon pilot lamp
- K1—Dpdt relay, 12-VDC (Magnecraft W88-X7 or equiv.)
- M1—0.50 μ A. meter movement (Lafayette 99E 50429 or equiv.)
- PB1—Spst miniature pushbutton switch, normally open (Lafayette 99E 62184 or equiv.)
- Q1—Unijunction transistor, GE 2N2160 or equiv.
- Q2—50V @ 5 amps SCR (Motorola HEP 300 or equiv.)
- Q3—Field effect transistor, GE FET-1
- R1—40-ohm, 10-watt wirewound resistor
- R2—51,000-ohm, ½-watt resistor, 5% tol.
- R3—120-ohm, ½-watt resistor
- R4—360-ohm, ½-watt resistor

- R6—470,000-ohm, ½-watt resistor
- R7—2,200-ohm, ½-watt resistor
- R8—62,000-ohm, ½-watt resistor
- R11—1,500-ohm, ½-watt resistor
- R5, R9—50,000-ohm, linear taper potentiometer (IRC Q11-123 or equiv.)
- R10—2,000-ohm, linear taper potentiometer (IRC Q11-110 or equiv.)
- S1—Dpst momentary spring return switch (Lafayette 99E 61830 or equiv.)
- T1—Filament transformer; primary 117 VAC, secondary 12.6 VAC @ 2 amps (Stancor P-8130 or equiv.)
- Z1—50 PIV @ 1 amp bridge rectifier (Motorola HEP 175 or equiv.)

1—Line cord
 1—Neon lamp housing with clear lens (Dialco 52-0463-0997-211 or equiv.)
 1—4¼ x 7 x 4-in. sloping panel cabinet (Bud AC-1613 or equiv.)
 1—6 lug tie strip (H.H. Smith or equiv.)

Misc.—hardware, knobs, perforated board, flea clips, wire, solder, etc.

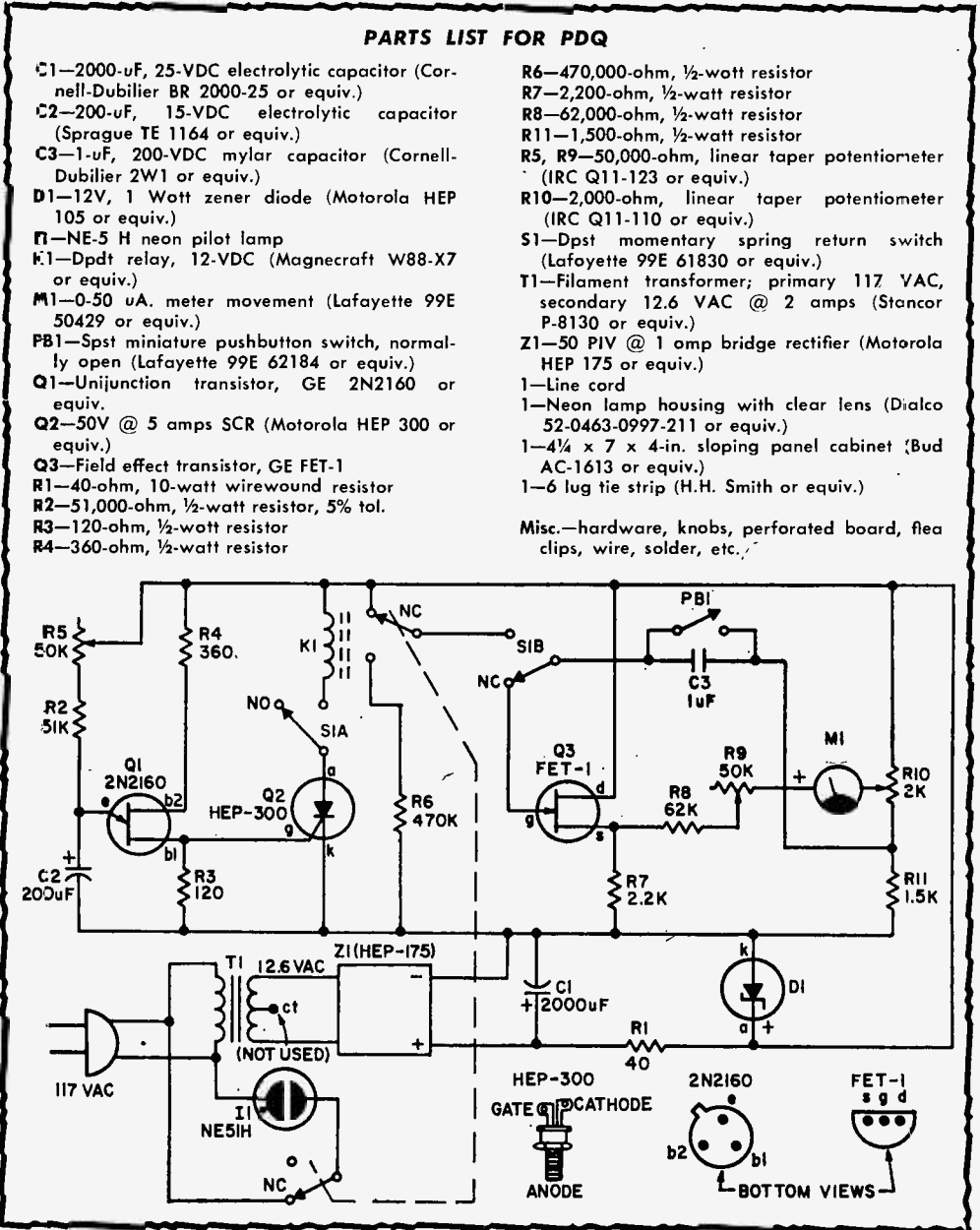

You get more for your money from NRI—

America's oldest and largest Electronic, Radio-Television home-study school

Compare. You'll find — as have so many thousands of others — NRI training can't be beat. From the delivery of your first lessons in the remarkable, new Achievement Kit, to "bite size," easily-read texts and carefully designed training equipment . . . NRI gives you more value.

Shown below is a dramatic, pictorial example of training materials in *just one* NRI Course. Everything you see below is included in low-cost NRI training. Other major NRI courses are equally complete. Text for text, kit for kit, dollar for dollar — your best home-study buy is NRI.



GET A FASTER START WITH NRI'S NEW EXCLUSIVE ACHIEVEMENT KIT

The day your enrollment is received your Achievement Kit will be on its way to you. It contains everything you need to make an easy, fast start in the Electronics training of your choice. This attractive, new starter kit is an outstanding, logical way to introduce you to home-study the way NRI teaches it . . . backed by a dedicated staff and the personal attention you should expect of a home-study school. It is your first special training aid . . . designed to make your adventure into Electronics absorbing, meaningful. Your Achievement Kit contains your first group of lesson texts; rich vinyl desk folder to hold study material; the industry's most complete Radio-TV Electronics Dictionary; valuable reference texts; lesson answer sheets; envelopes; pencils, pen; engineer's ruler—even postage. No other school has anything like it.

LEARNING BECOMES AN ABSORBING ADVENTURE WITH NRI TRAINING KITS

What better way to learn than by doing? NRI pioneered and perfected the "home lab" technique of learning at home in your spare time. You get your hands on actual parts and use them to build, experiment, explore, discover. Electronics come alive! NRI invites comparison with training equipment offered by any other school. Begin NOW this exciting, practical program. It's the best way to understand the skills of the finest technicians—and make their techniques your own. Whatever your reason for wanting to increase your knowledge of Electronics . . . whatever your field of interest . . . whatever your education . . . there's an NRI instruction plan for you, at low tuition rates to fit your budget. Get all the facts about NRI training plans, NRI training equipment. Fill in and mail the attached postage-free card today.
NATIONAL RADIO INSTITUTE, Wash-
ington, D.C. 20016.

OVER 50 YEARS OF LEADERSHIP



IN ELECTRONICS TRAINING

This is an example of material included in just one NRI course. Other courses are equally complete. But NRI training is more than kits and "bite-size" texts. It's also personal services which have made NRI a 50 year leader in home-study. Mail postage-free card today.

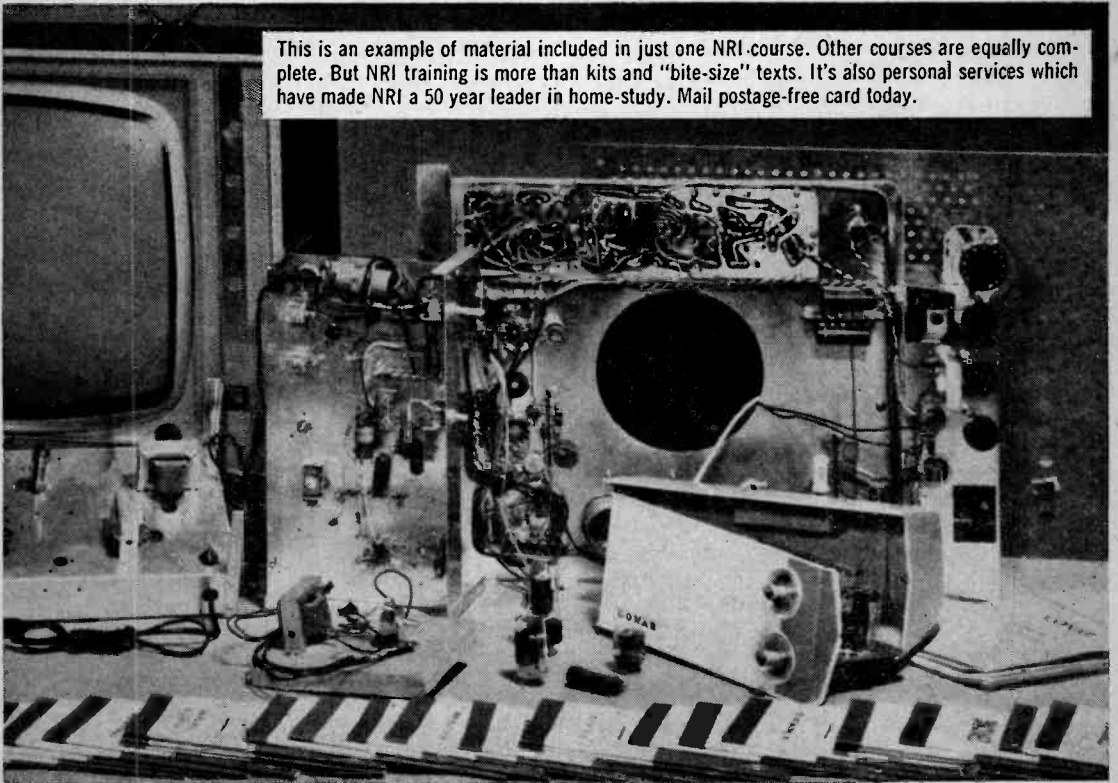

GREAT MEN OF SCIENCE



by Webb Garrison

STALKING through workshops of the military arsenal at Munich, Bavaria's prime minister hesitated. He wet the tip of an index finger, waved it about for an instant. Then he turned to workmen busy boring a cannon.

"What are you doing differently today?" he demanded.

"Nothing, sir. We work just as always," a foreman responded.

"But you do not always find your brass becoming hot?" probed the prime minister.

His subordinates tried to conceal their chuckles. "But of course," the foreman said. "Always, when one bores a cannon he runs the risk of burning his hands. Have you never heard that proverb, my lord?"

Count Rumford shook his head impatiently. This fellow was bordering on impertinence. Swinging his swagger stick he broke off the conversation and moved briskly to another section of the workshop. But he pondered the meaning of what he had heard—and felt.

A few months later, in London, he arranged an experiment to prove a radical new theory. All the effects of heat were universally believed due to action of a subtle fluid known as *caloric*. No one had ever seen or measured caloric, but every physicist in Europe took it for granted. All but Rumford, that is.

In a flash of intuition he had leaped to

the conclusion that heat is not a substance—but an effect or "form" of motion.

To demonstrate that heat couldn't possibly be a substance, he inserted a blunt steel borer into a brass cannon. Into a box surrounding the cannon he poured 26.5 pounds of cold water. Then he signalled for artisans to set their machinery in motion.

"The cylinder, revolving at the rate of about 32 times in a minute, had been in motion but a short time when I perceived, by putting my hand into the water and touching the outside of the cylinder, that heat was generated," Rumford reported to the Philosophical Society in 1798.

Using a thermometer, at the end of an hour he found that the temperature of water in the box had been raised 47°. Half an hour later, as the boring continued without interruption, water measured 142°. At the end of two hours, its temperature was 178°. About half an hour later, water in the box surrounding the cannon *boiled without any fire*.

Count Rumford demolished all inherited ideas about heat, laid the foundation for the modern science of thermodynamics. Contrary to all that seemed logical to his contemporaries, he showed that friction (or motion) produces heat by affecting substances at the molecular level.

(Continued on page 98)

SCIENCE
FAIR
PROJECT

the MOVING COIL METER



Here's a real winner for a Science Fair project. It gives you the opportunity to show off your knowledge and understanding of basic measuring instruments as well as your dexterity with tools.

In previous issues we included articles on how to build more primitive meters. The August/September 1969 RADIO-TV EXPERIMENTER (the former name of SCIENCE AND ELECTRONICS) featured a construction project on a hot-wire ammeter. The October/November 1969 SCIENCE AND ELECTRONICS detailed construction of a moving-vane type meter (SnFe Moving Vane Ammeter). Now we consider you as graduate students ready to build the more sophisticated moving-coil type meter.

Moving-coil meters are used universally to measure DC current in all types of test instruments because they are highly sensitive, rugged and reliable, and relatively

Build our accurate model of a moving coil meter and learn exactly how they work

by Charles Green, W6FFQ

MOVING COIL METER

inexpensive. They can also be used to measure AC current by first rectifying the AC with a small meter rectifier. Meters to measure AC directly without using a rectifier may look very similar to DC moving-coil meters. However, they are moving-vane instruments.

How Meters Read. The name moving-coil

meter implies that a coil of wire will move whenever current flows through it. All DC moving coil meters employ a coil of fine wire suspended in a strong stationary magnetic field. The coil is pivoted so that interaction between the magnetic field of the fixed permanent magnet and the magnetic field created by the coil carrying the DC current being measured, rotates the moving coil assembly.

A pointer, attached to the moving coil,

BILL OF MATERIALS FOR MOVING COIL METER

- A—6 x 7 x 3/4-in. white pine
- B—3/4-in. sq. x 1 1/2-in. white pine (4-Required)
- C—4 x 5 x 1/4-in. plywood
- D—1 1/4 x 1 x 1/4-in. plywood (see text)
- E—1 3/4 x 1 x 3/8-in. plywood
- F—3/8 x 1 x 3/16-in. white pine with end notch
- G—3/4 x 1 1/2 x 1/4-in. plywood with end notches
- H—3/4-in. sq. x 2-in. white pine (see text)
- I—3/4 x 7/8 x 1/4-in. plywood with end notches
- J—1/2-in. sq. x 3/4-in. balsa wood with slot
- K—Alnico magnet (Lafayette 14E33028 or equiv.)
- L—Rubberband (see text)
- M—Meter pointer (#18 copper buss wire—see text)
- *N—50 turns 38 enameled magnet wire (see text)
- O—Five #4 x 1/2-in. wood or sheet metal screws (Lafayette 13E43748 or equiv.)

- P—Solder lugs (Lafayette 13E43433 or equiv.) (6-Required)
 - Q—Fahnestack clips (Lafayette 33E71028 or equiv.) (2-Required)
 - R, S—8-32 x 1 or 1 1/4-in. machine screw and nut
 - T—4 rubber bumpers
 - U—4 x 5 1/2-in. heavy white paper for meter scale
- Misc.—Hookup wire, 200-ohm rheostat (Lafayette 33E16064 or equiv. 1 1/2-V. battery, VOM or DC milliammeter

* 1/4 lb. #38 enameled magnet wire (Lafayette 32E30802 or equiv.) * If #38 not available use wire from an audio transformer or the secondary of an old power transformer. You may have to add or subtract turns because of differences in wire gauge to have meter as sensitive as the model.

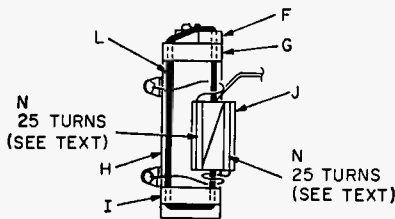

DETAIL AA

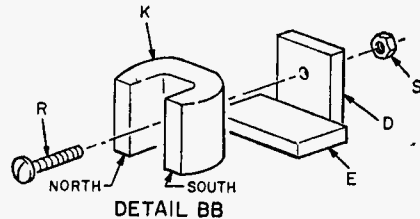

DETAIL BB

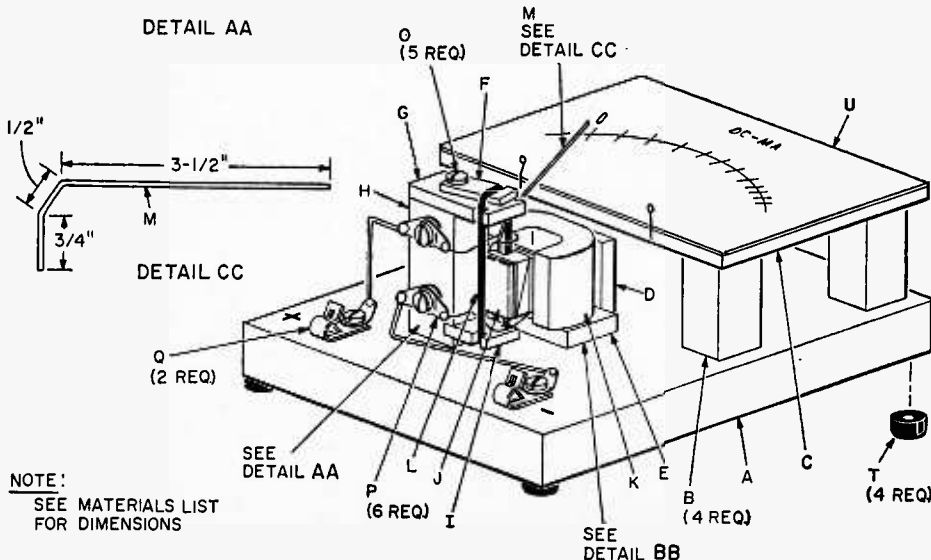

NOTE:
SEE MATERIALS LIST
FOR DIMENSIONS

is deflected across an arced line calibrated in units to provide a relative value for the measurement. A hairspring formed in a helix is fastened to the coil at one end and to the basic structure of the meter at its opposite end.

As the coil is rotated by current flow, it exerts force against the spring. When the resistance of the spring becomes equivalent to the rotating force, the pointer stops and we read the value on the scale at the point directly under the pointer. An adjusting screw is provided to set the pointer on the scale's zero when no current is flowing.

In order to ensure greater accuracy means are taken to reduce friction and drag of the moving coil to a minimum. The coil is usually wound on a very lightweight, non-magnetic metal form which is pivoted in jeweled bearings. Within the last few years a new method of suspension called taut-band suspension has been developed. Instead of using jeweled pivots with their inherently small friction to suspend the moving coil the coil assembly is suspended on a thin metal strip that is stretched tight to hold the coil accurately in position. The helical hairspring is dispensed with by twisting the thin metal strip. This method of suspension provides an even more friction-free meter movement which results in a more sensitive instrument.

Be An Instrument Maker. As you can see from our photos and drawing, our model of a moving-coil meter has been made in a very simplified form to facilitate construction. It's a taut-band moving-coil instrument by virtue of the rubber band suspension of the moving-coil assembly. We used wood for the various supporting structures because it's easier to work with and most ev-

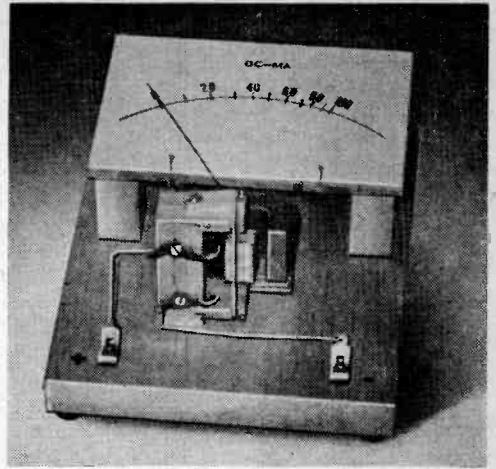

Here's how your finished MCM will look. Its innards are very similar to a bought meter.

eryone has the very few hand tools required.

Size is relatively unimportant. However, we suggest you follow the dimensions and construction details given in the drawing and Parts List. In this way you should have no difficulty in making the meter and you won't have to fiddle with changing the number of turns of wire for the moving coil to compensate for a change in physical size.

You should cut out all of the various pieces of wood and sand them smooth before actually starting to assemble the meter. Mount rubber feet on the bottom four corners of the base (A) and then glue the 4 supports (B) to A, as shown in the drawing. Next cement the scale platform (C) to these supports. We used our electric glue gun, but epoxy cement, Elmer's glue, Pliobond, etc., can be used with equal success.

Now you're ready to cement the magnet and moving-coil assembly supports to base A. Pieces D, E, G, and I are made from 1/4-in. plywood. First step is to cement D and E in their respective locations and fasten the magnet in place. If the magnet you use isn't drilled at the bottom center of the U to allow a bolt to go through it to hold the magnet in place, it too can be cemented to D and E.

At this point the main support block H should be readied for cementing. But first you must notch it out so that piece I can be properly fastened to it. Hold H on the base (A) adjacent to piece E and mark H

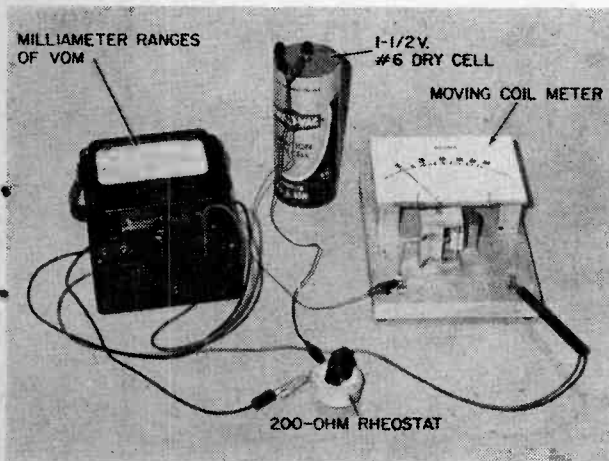

A VOM is very helpful in calibrating the Moving Coil Meter. If no VOM is handy try a 0-100 mA milliammeter in same circuit.

MOVING COIL METER

so that the top of the notch will be even with the top of piece E. The notch should be about 1/4-in. deep. Best way to determine its depth is to hold piece G in position at the top of H and place piece I so that its notched end is even with the notched end of G.

Mark the depth of the notch in block H based on the position of the end of piece I that will be inserted in the notch when its free end is matched with piece G as mentioned above. Be sure that the notch in block H is cut square so that the surface of piece I will be square with the surface of block H when I is cemented in place. The notches in the free ends of I and G are required only to hold the rubber band in position. Cement block H in position, and also piece G to block H as shown in our drawing.

The form block for the moving coil (J) is made from balsa wood, which is lighter in weight than any other wood and therefore contributes to the sensitivity of the in-

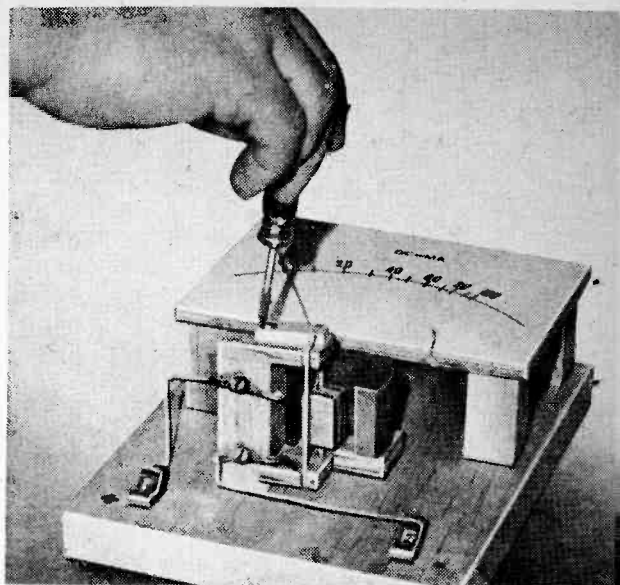

To zero pointer, simply loosen screw and move wood block, thus repositioning coil assembly.

strument. Cut a slot in the center of J as shown in our drawing. The rubber band (L) is cemented in this slot. We used a rubber band approximately 1 1/4 x 3/8 x 1/16 in.

The moving coil is made in two sections by winding 25 turns of #38 enameled magnet wire on each half of J. After completing the first 25 turns, without cutting the wire, continue to wind another 25 turns on the other half of J in the same direction. Put a touch of cement to the ends of each coil to hold the wire in place and leave 6-in. lengths of the start and finish of the two-section coil for future connection to it.

(Continued on page 100)

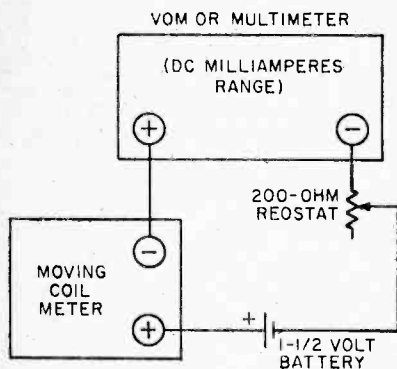

You don't have to use a VOM or multimeter for calibrating your Moving Coil Meter. Any 0-100 mA or higher milliammeter will do the job just as well, provided that its accuracy is fairly good.

By this stage you've almost completed the project. Except for cementing the scale on its platform, mounting the moving coil, and calibrating it, you're ready to make measurements or enter the Fair.

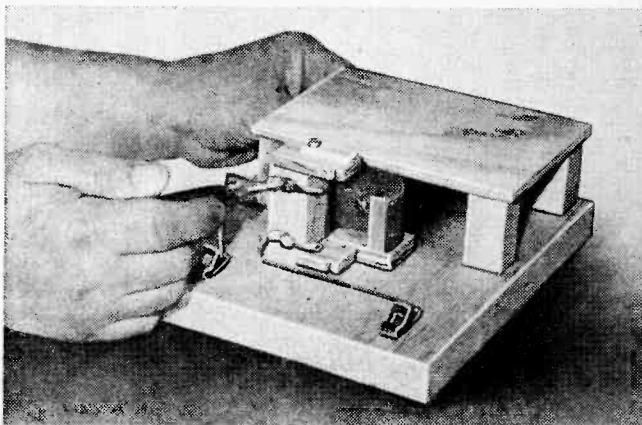

WEE WILLY Wailer

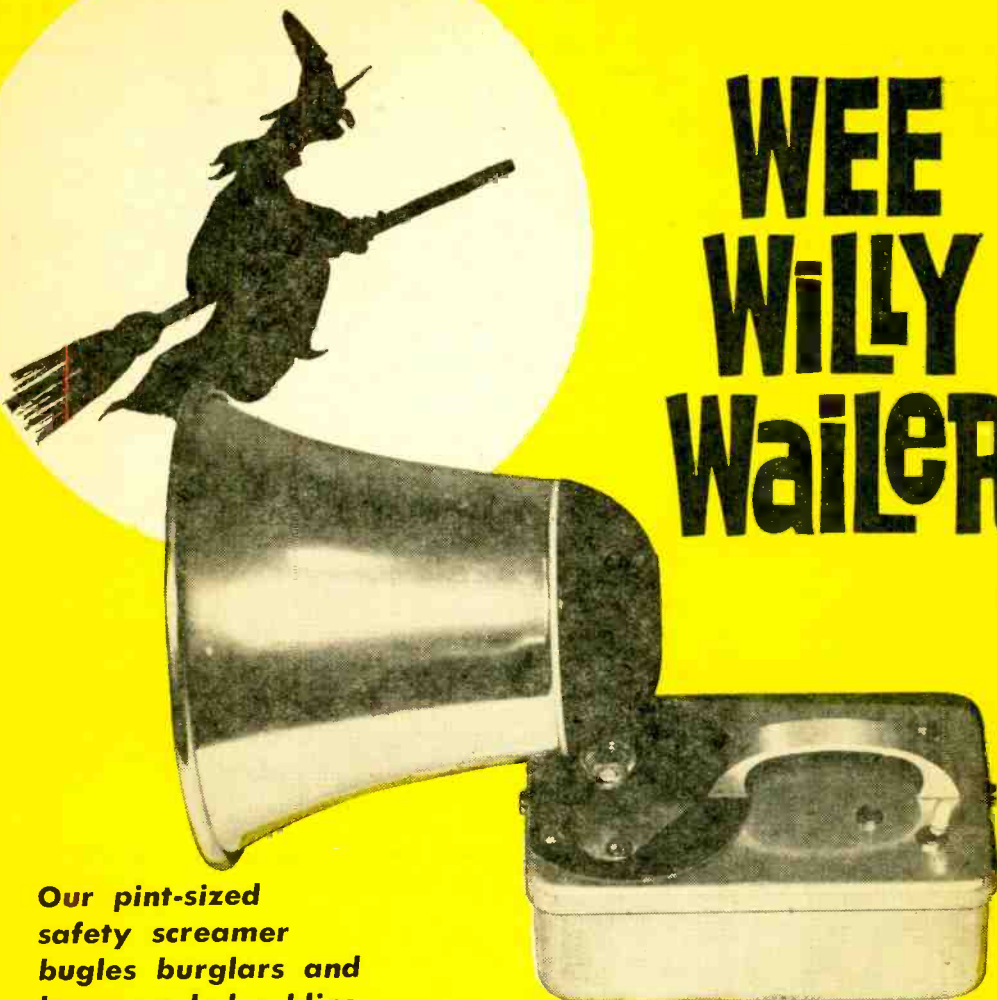

**Our pint-sized
safety screamer
bugles burglars and
harasses hobgoblins**

by Charles D. Rakes

HALLOWEEN will soon be creeping up behind us, pointing its bony hand toward Jack o' Lanterns, hobgoblins, and pumpkin pies. If a member of your family gleefully participates in this great annual Trick-or-Treat Rite, you can add to his Hallowed Eve's tomfoolery with our Wee Willy Wailer. As Wee Willy's name implies, it's an electronic siren small enough to tuck under a gypsy, or ghoul, or giant costume—and big enough in the sound department to scare the shoes off your neighbors or the pants off a burglar. W.W. Wailer's no ordinary screamer, either; it can imitate a police siren's rising and falling pitch down to the last detail. And you won't need to grovel for funds City-Hall style to build Wee Willy, as fifteen leaves of Washington lettuce pay our screamer's way onto your workbench.

WEE WILLY

Satanic Sounds. Muscle your orbs toward Wee Willy's schematic. You'll see it's a three-stage affair consisting of a unijunction transistor sawtooth oscillator, speaker power-amplifier stage, and a field effect transistor hooked up as a variable resistor.

Let's see how Wee Willy wails. When power's first applied via switch S1, unijunction transistor Q2 merely sits there like a three-legged lump. It doesn't do anything because it's not biased sufficiently in its forward-conducting state. Transistor Q3's direct-coupled to Q2's base 1; if Q2 doesn't generate pulses, Q3 has nothing to do. Naturally the end result is earnumbing silence from the speaker.

We'd like to give you a few words of

wisdom about that speaker. Any miniature speaker of 8-ohm impedance you can scrounge up works in this circuit. For instance, you've probably cannibalized many an All-American Five for its 4-ohm speaker. If this rings your brain's bell, go ahead and bring two of those golden toners to life again by wiring them in series.

Want more sound power from your siren? Find *two* speakers having identical 16-ohm voice-coil resistance. Wire them in parallel, and connect the pair where one speaker's shown in the schematic. But back to Wee Willy's modus operandi.

You're standing in a neighbor's doorway, treat bag in hand, and it's time for your wailer to give with its gangbusters introduction. Press switch S2, and capacitor C1 begins to charge toward the battery's peak positive voltage through resistor R1. This action, in turn, drives Q1's gate positive; in effect, we're causing Q1 to conduct more

PARTS LIST FOR WEE WILLY WAILER

B1—18-Volt battery (2 Burgess 2U6 or equiv. in series)
 C1— μ F, 50 VDC electrolytic capacitor (Sprague TE-1301 or equiv.)
 C2— μ F, 100 VDC mylar capacitor (see text) (Sprague 10491 or equiv.)
 C3—100- μ F, 25 VDC electrolytic capacitor (Sprague TE-1211 or equiv.)
 Q1—2N5458 transistor (Motorola)
 Q2—2N2646 transistor (Motorola)
 Q3—MJE520 transistor (Motorola)
 R1—150,000-ohm, $\frac{1}{2}$ -watt resistor (see text)
 R2—330,000-ohm, $\frac{1}{2}$ -watt resistor

R3—8,200-ohm, $\frac{1}{2}$ -watt resistor
 R4—560-ohm, $\frac{1}{2}$ -watt resistor (see text)
 R5—220-ohm, $\frac{1}{2}$ -watt resistor
 R6—100-ohm, $\frac{1}{2}$ -watt resistor
 R7—4,700,000-ohm, $\frac{1}{2}$ -watt resistor (see text)
 S1—Spst switch (Continental-Wirt GF 323 or equiv.)
 S2—Spst momentary switch (Switchcraft 101 or equiv.)
 Spkr—Speaker with 8-ohm voice coil (see text)

Misc—Battery connectors, battery holder, case, flea clips, hardware, perf board, solder, wire.

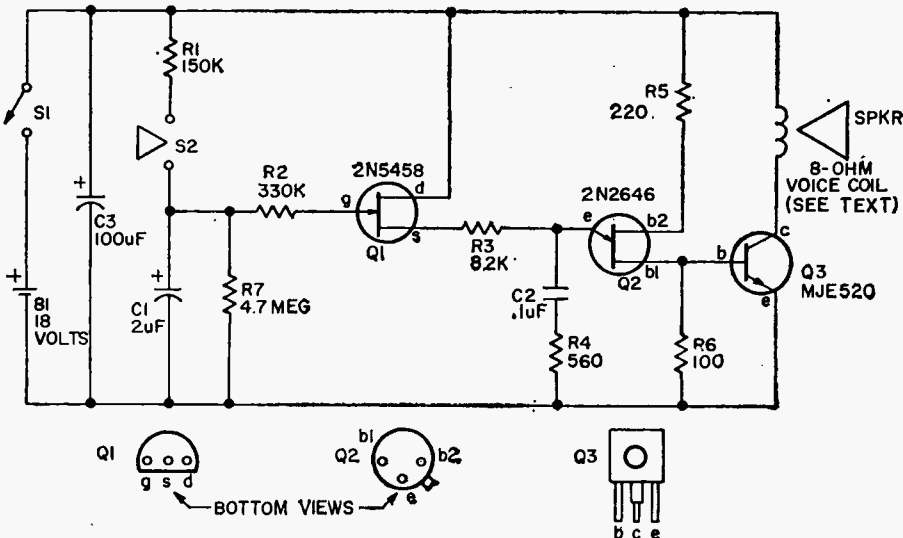

Turning Willy into burglar bugler entails few changes. First situate speaker so it will make itself heard in area being protected. Then substitute trip wires for switch S2. Arrange wires at devices to be protected so they make contact when they're touched. You can protect any number of your valuables by connecting all trip-wire sets in parallel with switch S2.

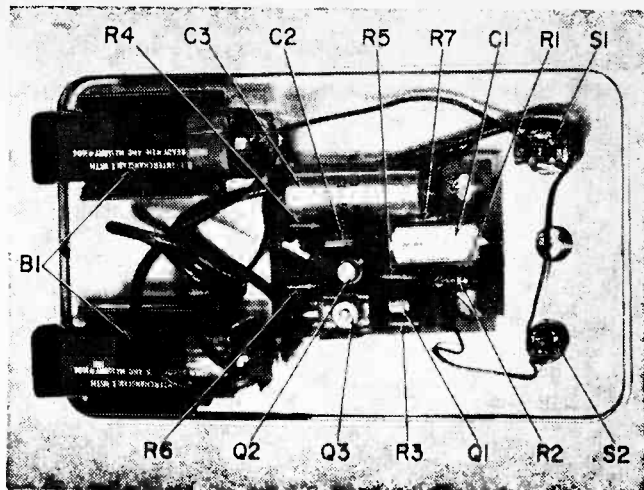

heavily by increasing the FET's gate bias.

As Q1 is driven harder and harder, more current's drawn through resistor R3. This resistor is in series with Q1 and Q2. As more current flows through R3, transistor Q2's emitter voltage also rises. At some point Q2 will start to behave like a sawtooth oscillator and, *voila*, Wee Willy lets loose. But hold on—you're not finished yet!

Capacitor C2, you'll remember, is charging up toward B1's 18-volt level. Yes, we're driving Q1 harder, and drawing more juice through R3. Wee Willy's voice steadily rises from baritone to soprano, all the while serenading you and your hapless neighbor in fortissimo. Now take your finger off S2; the wailer will slowly shift its vocal range downhill. Capacitor C1's discharging through resistor R7, eventually bringing us back where we started from—pianoforte, and then silence.

Workshopping Wee Willy. Our siren falls into the "anything goes" construction category. The author built his siren into a 5 x 3 x 1/4-in. metal box. He even whipped up

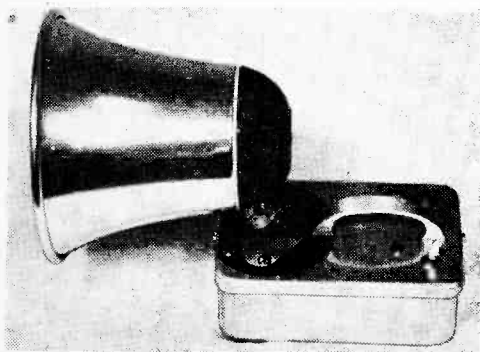

a printed circuit board for his prototype version. But we like to get more yocks using Wee Willy, so to save time it's the perfboard route for us. Note B1's two 9-volt batteries connected in series. They can be secured to the perfboard in any manner you can think of. The easiest and cheapest battery holder consists of a rubber band looped over the ends of each battery.

End loops of the rubber band are inserted through the perfboard, and connected together on the perfboard underside with a short length of wire inserted through these loops and twisted together.

We needn't say too much about electrolytic capacitor polarity. And do exercise caution while you're soldering home the transistors. These little devils could never appreciate heat applied to their leads.

You might try building Wee Willy into your treat bag or costume. If you've got a large head mask for the occasion, wire two speakers as described and glue them into your mask's cheeks. Other Frankensteins will find the treat holder's their bag. These poltergeists will glue S2 to the bag handle, so it's easy to activate.

If you want to fiddle with Willy's wail, then experiment with resistors R1 and R7. Varying these components' ohmic values changes capacitor C1's charge and discharge rate. Resistor R4 can serve as a volume control if you substitute a 1000-ohm potentiometer for it. And finally, varying capacitor C2 changes Willy's basic frequency range. ■

Funnel-shaped thing shown on top of prototype version is author's speaker. Lafayette Radio sells it as stock no. 99 E 45080.

DOIN' IT

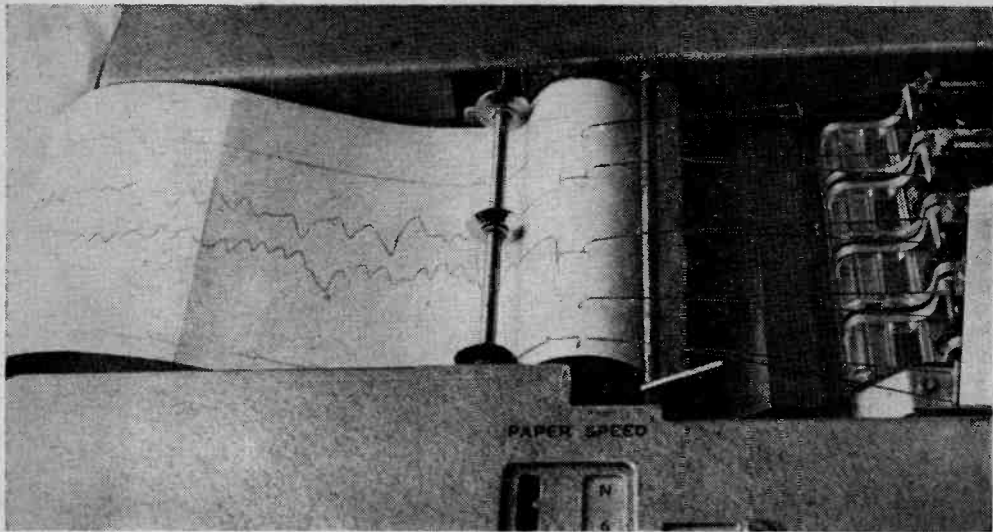

FOR DOGGIES

WHEN a London veterinarian could find nothing wrong with a Welsh terrier called "Fella," the dog went the route many a human has gone. He was referred to a specialist—in this case, Dr. Phyllis Croft, who is one of the first to use the electroencephalograph to determine what ails animals in the brain department.

Basically, the machine measures brain impulses. As such, it's used on humans to discover whether they have brain ailments. Similarly, this machine, which cost Dr. Croft some \$1500.00, will help her determine whether Fella is suffering from epilepsy, a brain tumor, or brain damage of any sort. When Fella was brought to her, Dr. Croft quickly attached the machine to his head with small needles which lead to the unit

by wires (the process is harmless and doesn't hurt the dog in any way). Once in operation, the machine measures the dog's brain impulses and automatically records them on a special kind of graph paper (see our photo above).

A leading animal specialist, Dr. Croft has already received a medal from the Royal Veterinary College for her work in improving conditions during animal surgeries and in many laboratories. If things go well for Fella, chances are he'll extend a thankful paw when Dr. Croft has concluded her work with him. After all, how many vets do you know who go to such lengths in an effort to return favors bestowed by the animal that's come to be known as Man's Best Friend? ■

Looking tense and anxious in manner of many a human patient, Fella sits quietly while electroencephalograph records his brainwaves. Plotted on graph paper (see above), charts help determine whether dog is victim of any kind of brain damage.

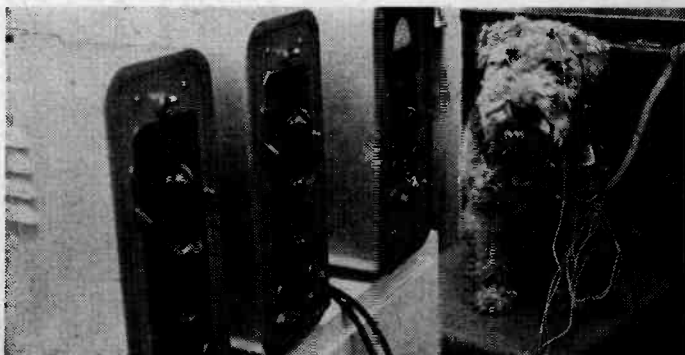

COLD-FLASH

By the
flashing lamp
in that
window
they shall
find you

by James G. Busse



BLINKING a light is no great electronic feat (there are dozens of circuits around for that purpose). But how about a blinking light that can be seen for several miles in the dark of night and that won't burn out unexpectedly? How about one that will run for more than a year from sunrise to sunset on a single lantern battery? And get this, what about one that will continue to operate in low temperatures till battery voltage drops considerably because of temperature and then will start up again when battery voltage is restored by rising temperature, without affecting loss of power or life? Believe it or not, you can build one for just a few dollars.

Cold-Flash is based on a high-performance, high-reliability blinker beacon originally developed in Canada for navigation and rescue applications. In its present form *Cold-Flash* makes an ideal camp, trail, and dock marker. Put one on your boat or camp trailer. Mount *Cold-Flash* on a buoy to mark the location of underwater obstructions or a favorite nighttime fishing spot. Two units will permanently mark the entrance to your driveway at home in any kind of weather. And these are but a few of the countless uses for *Cold-Flash*.

How It Works. Basically, *Cold-Flash* employs a spiked pulse generator coupled to a stepup transformer to produce a high-voltage pulse that fires a fluorescent lamp bulb, much in the manner of a strobe. There are only nine components in its all-solid-state circuit. Silicon transistors for Q1 and Q2 are mandatory for maximum efficiency, for resistance to temperature extremes, and for the ability to handle hefty pulses of millisecond duration that may reach half an amp or more when the unit fires.

A cadmium sulfide photocell (PC1) is used to turn on *Cold-Flash*

at dusk and to extinguish it at dawn. When the cell is exposed to normal daytime light levels, its resistance drops to less than a few hundred ohms, thus dissipating the charge on electrolytic capacitor C1. Its flash rate of approximately one flash per second, obtained with the capacitor and lantern battery specified in the Parts List, is established by the value of C1 and the impedance of the 6V battery (B1). Light levels to turn *Cold-Flash* off and on will vary somewhat, depending on the characteristics of PC1.

Long Battery Life. In the off state, current drain is less than 140 μ A, which accounts, in part, for the exceptionally long battery life afforded by the unit. Equally important is the use of a fluorescent lamp bulb, operating like a giant neon bulb, in place of the usual incandescent lamp with its current-wasting hot filament.

Another obvious advantage offered by the fluorescent lamp is that it will last for years in *Cold-Flash* since the starter filament in the lamp isn't used to initiate fluorescence that produces illumination. Also, for all intents and purposes, the fluorescent lamp is almost a foot-long source of illumination. In addition, its blue-white light can be seen at much greater distances than the yellow-white light from incandescent-type blinkers.

If cold weather should affect the battery's output voltage, causing it to eventually drop below 2 volts, *Cold-Flash* will stop in the off state, thus minimizing power drain. It will start blinking again when the battery begins to recuperate as the temperature rises and the voltage reaches a couple of volts, provided, of course, that the light level outside is low enough to affect the photocell (PC1).

A right angled, dual panel, mirror-reflector, shown in our illustrations, was used to increase the unidirectional light output of *Cold-Flash*. The author used the model unit as a directional navigational aid. Actually, the fluorescent lamp assembly can be mounted permanently in any position to suit its particular application. It can even be used as an underwater beacon provided the lamp electrodes are properly insulated.

Construction. With the exception of the fluorescent lamp and the battery, all components are mounted inside a sturdy molded plastic box, 3 $\frac{3}{4}$ x 6 $\frac{1}{4}$ x 2-in., to protect them from the weather. Clear or black silicone rubber sealant, available from most

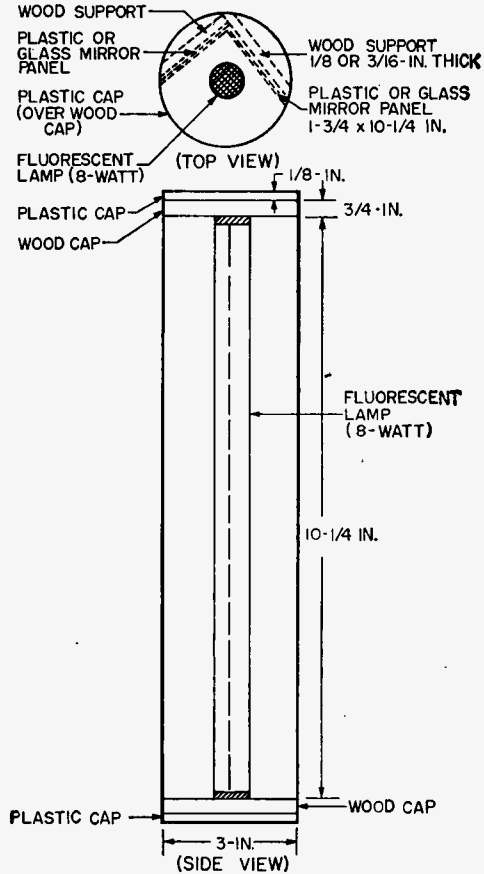

You can convert unidirectional Cold-Flash lamp assembly to omnidirectional one simply by omitting right angled mirrors. Make supports for top and base from rods.

hardware or auto parts stores, is used to seal the cover and the holes around P1 and P2, S1 and PC1. Don't forget to also seal the bolts holding transformer T1 and the perfboard subassembly in place in the cabinet.

Circuit components Q1, Q2, C1, R1, and R2 are mounted on a small piece of perfboard, cut to fit the contour of the inside of the plastic box. Interconnected by point-to-point wiring, they form a subassembly. Parts layout isn't critical, but keep in mind that the power transistors' cases are their collectors. Therefore, insulate them from one another and from the other components. Use two small bolts to secure each of the transistors to the perfboard.

Drill two small holes through the top of the plastic box for the leads from PC1. The photocell is held in place on the outside top

PARTS LIST FOR COLD-FLASH

- B1—6-V lantern battery (Eveready #731 or equiv.)—see text
 C1—100 μ F, 15 V electrolytic capacitor (Lafayette 34E5144 or equiv.)
 I1—8 W. miniature fluorescent lamp bulb FBT5/CW)
 P1—2 contact plug (may be any type available)—optional, see text
 P2—2 contact polarized plug (Lafayette 34E20015 or equiv.) optional, see text
 PC1—Cadmium sulfide photocell (Lafayette 99E63216 or equiv.)
 Q1—Npn silicon transistor, AF power type, GE-23
 Q2—Pnp silicon transistor, AF power type, GE-26
 R1—47,000 ohm, $\frac{1}{2}$ watt resistor
 R2—680 ohm, $\frac{1}{2}$ watt resistor
 S1—Spst subminiature toggle switch (Lafayette 99E61624 or equiv.)
 S01—2 contact socket to match P1
 S02—2 contact polarized socket to match P2 (Lafayette 34E20460 or equiv.)
 T1—5 to 8 watt tube type output transformer: primary, 16K to 25K ohms; secondary, 3.2 ohms (Lafayette 33E81415 or equiv.)
 1— $6\frac{1}{4}$ X $3\frac{3}{4}$ X 2-in. plastic box (Lafayette 19E20016 or equiv.)
 1—Blank cover for above box (Lafayette 19E37010 or equiv.)
 Misc.—Bolts, nuts, silicone rubber sealant, press-on letters (Datak or equiv.), zip cord, two plastic or glass mirror panels/and scrap wood for mounting them (for the corner reflector of the fluorescent lamp bulb), wire, solder, hot melt glue (optional), etc.

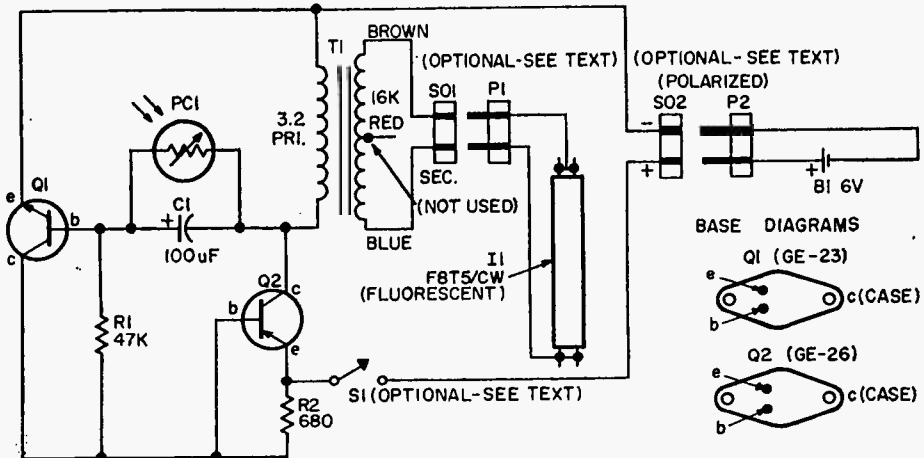

surface of the box with the silicone rubber sealant. For maximum sensitivity, PC1 must look straight up into the sky. Power switch S1 is optional—you can turn *Cold-Flash* on simply by plugging in the battery leads, thus not needing a switch to turn the unit on or off. Aside from saving the cost of the switch, it's one less component that has to be sealed.

If your *Cold-Flash* will be permanently installed, you can eliminate both plugs and sockets. Drill two holes to pass the battery and fluorescent lamp leads through the side of the plastic box. Use grommets to protect the wires and help in sealing the openings. On the other hand, the plugs and sockets are worthwhile accessories if you make your *Cold-Flash* portable so you can take it with you when you go boating or camping. The fluorescent lamp bulbs are relatively inexpensive, selling for under \$2.00; there-

fore, you may prefer to mount several of them permanently on your boat, your trailer, your home, etc., and move just the control and power source with you wherever you may roam. In that way you get the benefits of owning several *Cold-Flash* units with an investment just a little more than the cost of one or two.

Power transformer T1 is a speaker output transformer used as a step-up transformer. Thus, as we have applied it, the voltage of the pulses fed its 3.2-ohm primary (normally the secondary when used as a speaker transformer), will be raised by a factor of more than 50. The output of its 16,000- to 25,000-ohm secondary (actually the primary in its original circuit application) is fed directly across the fluorescent lamp to fire it to produce a burst of light. Since the fluorescent lamp is really a self-rectifying tube, no

COLD-FLASH

external rectification is required.

Though you would certainly save space and weight by using a transistor-type output transformer, the 5- to 8-watt capacity of the larger tube-type transformer reduces the possibility of momentary overload and subsequent insulation breakdown. Some output transformers, including the one specified in the Parts List, have an additional tap in their secondaries, which should be ignored for this application.

A word of caution. Though approximately 300 volts are developed with each short-lived pulse that emerges across the high-voltage output of T1, physical contact with this *hot* line isn't particularly dangerous. It does have a *bite* though, so take care in handling this line. Also, persons who may be susceptible to epileptic seizures shouldn't stare at a flashing *Cold-Flash* at close range.

Do not operate the *Cold-Flash* control unit without the lamp connected, or with a load greater than the 8-W fluorescent bulb we've specified. Though the unit will fire a smaller 4- or 6-W fluorescent lamp, loading the control unit with a larger lamp or a regular strobe tube will damage either one or both of the transistors. Accidental reversal of battery polarity input will almost always damage transistor Q2. That's why the polarized plug and socket is used for the battery supply leads.

Reflector Assembly. Solder the leads that

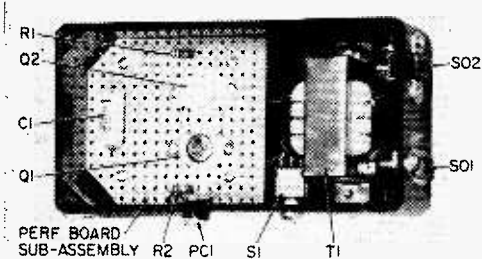

By mounting all parts except T1, S1, PC1, SO1, and SO2 on perfboard and keeping battery and lamp separate, there's ample room inside plastic box for complete unit.

connect the lamp to the control unit directly to the pin contacts at each end of the fluorescent lamp as shown in our drawing, making sure that there is good contact on both pins. Mount the lamp in whatever manner that best suits your particular application. It can be mounted inside a clear or

colored plastic tube sealed at both ends for safe marine installations.

Or, if you're looking for maximum light output in a specific direction, build a reflector assembly similar to the one shown in the photos and drawings. This reflector was fabricated from two plastic mirrors mounted on pieces of scrap wood cut to fit the mir-

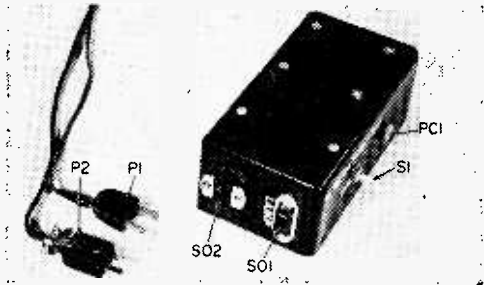

We used a polarized plug and socket for B1 to ensure correct polarity to unit at all times to avoid damage to transistors. PC1 should always be pointed skyward.

rors and assembled with an electric glue gun. (Glass mirrors will do just as well, though they may be a bit heavier.) Sockets for the fluorescent lamp bulb are superfluous since you won't be replacing it.

Checkout. Make certain that S1 is in the *off* position before plugging in the fluorescent lamp and the battery. Then flick the switch *on*. If enough light reaches PC1 to keep *Cold-Flash* in the *off* state, the lamp will flash only once. Cover the photocell with your hand and the lamp should begin flashing immediately at approximately one flash per second. Remove the cover over the photocell and it will stop flashing.

Now move *Cold-Flash* outside the shop. With PC1 *looking* up to the sky the lamp should stop flashing and start again as daylight diminishes or PC1 is shielded from outside light. There are no critical adjustments to be made. However, you may want to try a photocell having a different light response. The more sensitive the cell, the earlier *Cold-Flash* will come *on* in the evening and go *off* in the morning.

Troubleshooting. If construction details were carefully followed there should be no troubleshooting required. If the unit doesn't flash, turn *off* the power immediately and carefully doublecheck your wiring, particularly the polarity of the battery connections and the connections soldered to the fluorescent lamp. If the unit still doesn't flash, replace Q2 and, if necessary, Q1 in that order. ■

S&E BUILDS THE MITCHELL UNIFLASH...

... an electronic light gizmo for the portrait specialist

MITCHELL'S Uniflash is a 200 watt-second electronic flash that uses only a bare-bulb flashtube (no reflector) and an AC power supply. Essentially, it's a studio-type unit intended primarily for the portrait specialist.

As shown in our photos, Uniflash consists of two cord-connected units; an AC power supply, and a lamphead assembly which can be mounted on a lighting stand or on a camera tripod. The power supply is a wopper and is the main reason the Uniflash is a "studio" flash. It contains a voltage tripler that steps up the line voltage to 450 volts and two series-connected 3900- μ F storage capacitors for the flashtube energy. Since the effective capacity of series-connected capacitors of the same value is half the value of one capacitor, the watt-second energy (from $WS = \frac{1}{2} CV^2$) is approximately 200.

The lamphead assembly contains a socket for the plug-in flashtube, a few components for triggering the flashtube, and an AC

socket for the camera sync-cable. Unlike other electronic flash units, the sync-socket isn't polarized; this means that the sync-cable from the camera can connect to the socket either way. However, both sides of the sync terminals are isolated from the Uniflash's voltage bus and ground by 2 megohms from either terminal, so there's full safety in the sync-cable connection regardless of polarity.

Circuitry. The Uniflash circuit is about as straight-from-the-book as is possible, consisting of the absolute minimum circuitry needed to fire the flashtube. At the input is a line-powered voltage tripler that develops approximately 450 VDC. The output voltage of the tripler is fed to two series-connected storage capacitors. The reason for the series-capacitor connection is to allow the capacitors to fit into a cabinet of reasonable size.

Since each capacitor is 3900 μ F at 250 V, the series connection results in approximately 2000 μ F at 500 V. A single ca-

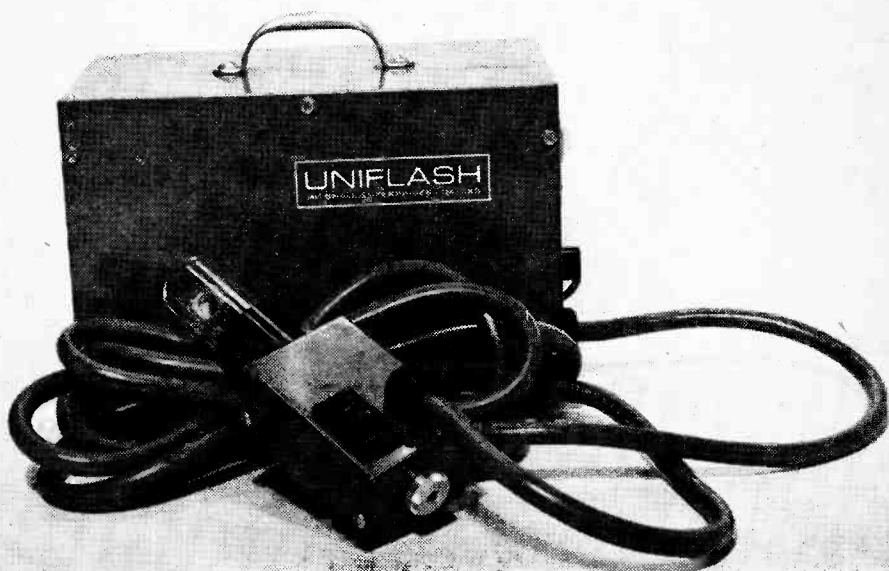

S&E BUILDS THE MITCHELL UNIFLASH...

capacitor rated 2000 μF at 500 V would be so tall the cabinet would be unnecessarily bulky; and while the two series-connected capacitors take up more bulk space than a single capacitor, the space is spread in a low profile and results in a smaller cabinet.

The capacitor energy is applied to the flashtube via a two-conductor cable. The tube's trigger coil is built into the base of

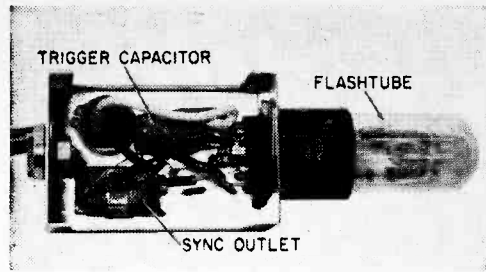

Lamphead includes non-polarized sync-outlet; trigger transformer is part of flashtube.

power supply or lamphead, so the only real care must be taken when checking the components in the event of a wiring error. Keep in mind that the 2900- μF capacitors store enough energy to lay a careless technician flat on his back, so super caution's the word.

If anything at all is wrong, discharge the storage capacitors through 5000-ohm, 5-watt resistors and then short the terminals for a few minutes before you stick your hands or fingers into the power supply. This shorting-out is necessary because a storage capacitor can bounce back after having been discharged through a resistor. On the other hand, you can't throw a short across the capacitors without first using a resistor discharge since the surge current through the shorting wire will literally weld the short to the terminals.

If you've made no wiring errors—and assembly is so easy there should be none—simply plug in the flash tube, apply the AC

(Continued on page 97)

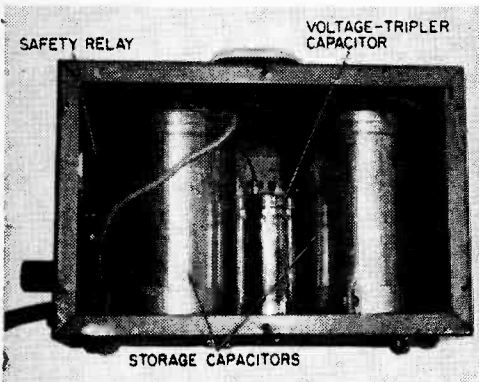

Power-supply cabinet is jam-packed with high-value capacitors; big ones are 3900 μF !

the flashtube so only an AC outlet (for the sync cable from the camera) and a trigger capacitor are required in the lamphead assembly. In total, it's a very simple and basic circuit, but one that works well.

Though not actually part of the flash circuitry, Uniflash includes a relay-controlled power switch for safety reasons. Voltage-tripler circuits have an unusual safety hazard, namely, that if the line cord is removed from the outlet and the power switch is *on*, it's possible for the voltage across one of the tripler capacitors to appear across the power plug.

To prevent this hazard, Uniflash uses a relay to apply and disconnect the AC power source. The power switch turns only the power relay *on*. If the line cord is disconnected or the power switch is turned *off*, the relay drops out and disconnects the line cord from the voltage-tripler power supply.

Building It. Kit assembly isn't difficult (there is, after all, but a handful of components). There isn't any parts jam in the

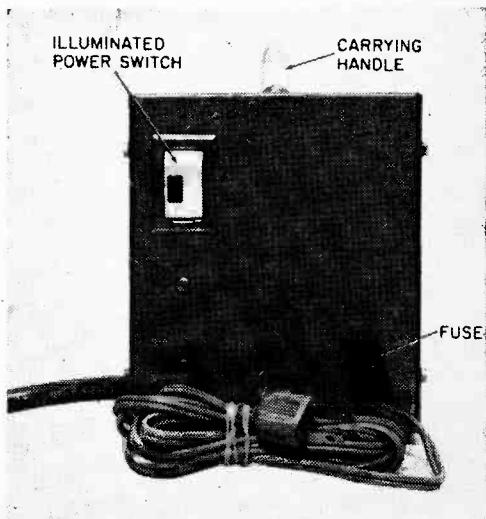

Rear of completed Uniflash. Fuse at lower right is intended to protect entire circuit.

S & E

tests a do-it-yourself

HOME BURGLAR ALARM

API's 208 will put you under by some 60 clams. Is it for you?



AMONG problems, home security must rank among today's top ten. Advertisements for "security" equipment abound in the pages of newspapers and national magazines. Unfortunately, most of this equipment is either worthless, too expensive for what it does, or too difficult for the average homeowner to use.

When you come right down to it, the best buy in home security equipment is professional equipment such as that sold and/or installed by professional installers and supply houses. A good example is Alarm Products International's Model 208 Time Delay Open Circuit Burglar Alarm.

The Model 208 system is specifically intended for the small homeowner or apartment dweller who isn't in a position to mount exterior alarm bells and key-type entrance locks (perhaps because the landlord frowns on anyone drilling holes in his doors). The system is housed in an 11- x 15- x 4-in. steel box that contains a 6-volt lantern-type power-supply battery, an 8-in.

alarm bell, a time-delay controller, a time-delay timing adjust, a key-type master switch, and a connecting block.

What Gives. The time-delay controller provides two independent protection circuits. One is the time-delayed alarm circuit for the entrance doors. Any normally open switch, such as a two-piece magnetic switch, is mounted on the entrance and connected to the 208's time-delay contacts. When the user sets the alarm with the master key, the time-delay controller allows up to 90 seconds for the user to get out the door. After this minute-and-a-half interval, the alarm is automatically armed.

If the door is opened, closing the switch, the time delay allows up to 90 seconds for the user to turn the master switch *off*. And if the alarm isn't turned *off*, the time delay closes the bell circuit and locks up, making the bell sound continuously regardless of whether the door is closed or the wiring cut.

The second protection circuit is the more

Key-type master switch on API's 208 provides only means of turning unit on or off.

Once tripped, alarm will continue to sound, even if all external wiring is cut. Only master key can silence alarm.

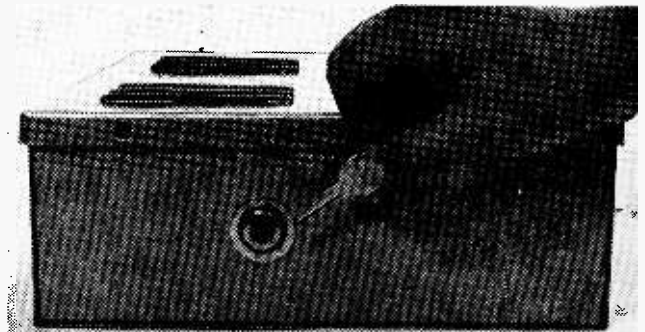

HOME BURGLAR ALARM

or less common instantaneous alarm, which can be used for either intruder- or fire-protection. Any number of normally open intruder or heat detectors can be connected in parallel with the 208's instantaneous alarm terminals. As soon as a detector is tripped by either forcing a door or window, or by excessive heat, the alarm bell is instantly locked *on*. Again, the alarm bell can only be silenced by turning the master key switch to *off*.

In the evening, before retiring, the entire alarm system is set *on* by simply turning the master switch to *on*.

Double Protection. The 208's internal equipment is normally protected by both the swing-away front panel and an internal steel plate. (The plate has been removed in our photo for clarity.) Once the alarm is tripped, either by the time delayed door circuit or

the bell louvre cannot silence the alarm.

The time-delay controller is solid-state and requires just a few microamperes of battery current even when the alarm is armed. The battery will, therefore, last its normal shelf life while standing-by for protection. As a rule of thumb, the lantern battery should be replaced about once a year, unless it runs down sounding warning of an intruder or a fire.

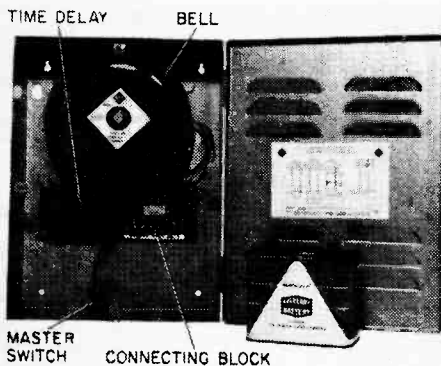
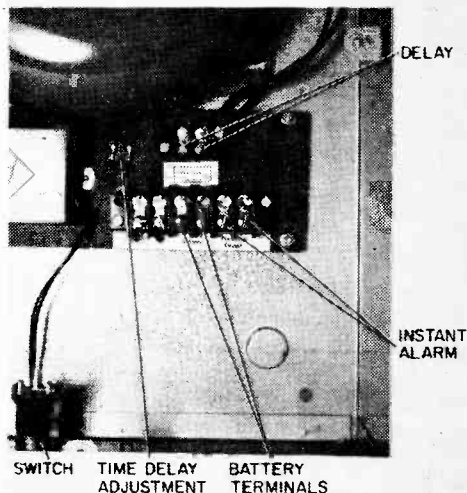

Completely self-contained, API 208 houses everything except detector switches in steel case. Protective steel panel has been removed here to reveal details of interior.

the instantaneous circuit, the alarm bell locks up to the battery. Result is the bell will keep ringing even if the connecting wires are cut, the alarm is torn from the wall, or the entire unit is dunked in a tub of water. Nothing can stop the alarm from sounding other than the master key. And because of the double-panel construction, even squirting shaving cream right through

All circuit connections are made to barrier-type terminal strip within unit. Time delay adjust pot determines interval between time door is opened and alarm sounds off.

Summing Up. The A.P.I. Model 208 Burglar Alarm performs as well as can be expected of professional-type equipment. It stands head and shoulders above "hobby circuit" alarms and ultrasonic alarms that cover small areas at high cost, and which trip when a child gets up for a glass of water.

The A.P.I. Model 208 alarm is available only from professional equipment suppliers and installers. Price of the alarm unit, less intruder and fire detectors and battery, is about \$60.00. For additional information, see your local A.P.I. dealer or write Alarm Products International, Dept. TC, 24-02 40th Ave., Long Island City, N.Y. 11101.

A Home Protector Kit consisting of the 208 alarm unit, three magnetic door/window switches, and two heat detectors is available prepaid for \$69.95 from Custom Components Div., Box 153, Malverne, N.Y. 11565. (Additional switches and heat detectors are \$3.55 each.) ■



WHO invented television?

If a "Mr. Television" award were to be given to the inventor of television, the nominees for the title would be many indeed. Seldom has a modern invention evolved from the efforts of so many far-sighted inventors over so long a period of time. The list of nominees, to mention just a few, would certainly include.

- G. R. Carey, a Boston inventor who designed the first crude television in 1875, using a screen consisting of a mosaic of selenium cells, each individually wired to a corresponding electric bulb;
- Paul Nipkow, who, in 1884, received a German patent on a TV system based on a mechanical scanning disc (years before the age of electronics);
- K. F. Braun, who perfected the cathode ray tube in 1897 and paved the way for electronic methods of television;
- Russian physicist Boris Rosing and English scientist A. A. Campbell-Swinton, who independently developed electronic scanning systems based on the cathode ray tube, in 1907;
- J. L. Baird, Scottish inventor whose genius developed the mechanical scanning systems of Nipkow to their highest degree of perfection and who devised a color television system in the 1920s;
- Philo T. Farnsworth, American inventor whose research during the

1920s and 1930s resulted in the granting of more than 100 patents, many on inventions basic to modern TV.

High on any list of candidates for the "Mr. Television" award would be the name of Vladimir Kosma Zworykin, pioneer of modern television and inventor of the TV camera's "electronic eye"—the *Iconoscope*.

Born in Mourom, Russia in 1889, Vladimir Zworykin received his early education in his native land, graduating from the Petrograd Institute of Technology in 1912 with a degree in electrical engineering. Later the same year the young scientist traveled to France to begin his graduate studies in X-ray research. His studies were cut short by the onset of World War I and he returned to Russia where he served as a radio officer in Signal Corps of the Russian Army. In 1919, at the end of the war, he emigrated to the United States and became a naturalized citizen in 1924.

During his studies at the Petrograd Institute, Zworykin worked under Professor Boris Rosing—one of the rare scientists of the day who believed that television was more than just a science fiction dream. Under the influence of Professor Rosing, Zworykin became convinced that the key to television was not in the mechanical system of Nipkow, but in a yet-to-be discovered *electronic* system based on cathode-ray tubes.

Shortly after his arrival in the United States, Zworykin moved to Pittsburgh where, as a research scientist with Westing-

FAMOUS PATENTS

house Electric and Manufacturing Company, he was able to begin his investigations in electronic television. By 1923 he had developed a complete electronic television system.

Zworykin's system incorporated the first practical television camera—developed from the cathode-ray tube. He named it the "Iconoscope", from the Greek words "Eikon" meaning image, and "Skopon", meaning to watch. In the original Iconoscope, the image to be telecast was focused on a composite plate within the cathode-ray tube. The plate consisted of a mosaic of photo-electric material and a thin layer of aluminum on opposite faces of an insulating material (aluminum oxide). Zworykin used potassium hydride as the photo-electric material. (Later research led to the substitution of more efficient photo-electrics, such as caesium-silver compositions, and other insulating layers such as mica.) In operation, each segment of the mosaic consists of a

tiny dot of photo-electric material which forms one plate of a miniature condenser, the other plate being the thin sheet of aluminum. As the image to be telecast is focused through the TV camera lens onto the photo-electric mosaic, a pattern of charges corresponding to the visual image is created. The pattern is "scanned" by a beam of electrons from the electron gun in the neck of the tube.

Zworykin applied for a patent on his television system—including the Iconoscope—in 1923. Other television researchers claimed similar inventions and a series of legal proceedings followed, to determine the true inventor. After fifteen years of legal proceedings, Zworykin was determined to be the first inventor and his patent was allowed to issue. U.S. Patent No. 2,141,059 covering his fundamental discoveries of the early 1920s was finally granted on *December 20, 1938*.

The Iconoscope—key to the early development of television—has been replaced to a large degree by more efficient camera tubes. However, it is still used for a number
(Continued on page 97)

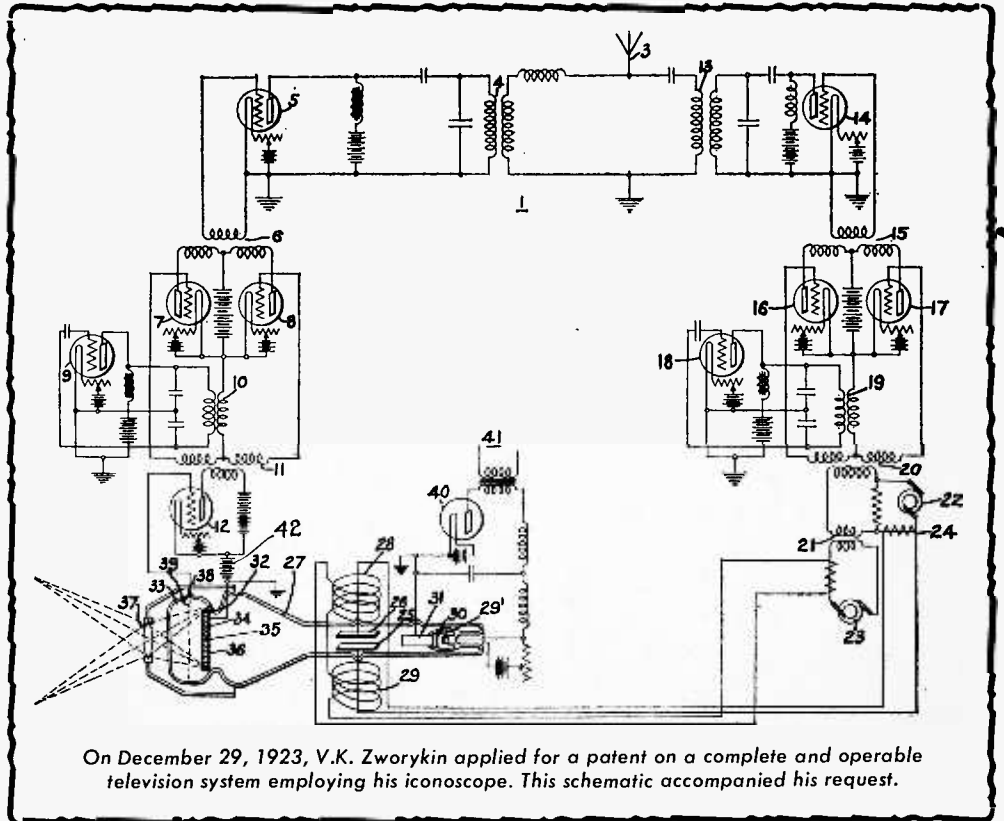

On December 29, 1923, V.K. Zworykin applied for a patent on a complete and operable television system employing his iconoscope. This schematic accompanied his request.



Verry Interresting...diss

VOODOO RADIO

HAITI might just be the strangest country anywhere on the DX scene. Its three best-known stations are 4VB (*La Voix de la Révolution Duvaliériste*), Radio Lumiere (4VU), and 4VEH. As it happens, 4VB is spokesman for the regime headed by "Papa Doc" Duvalier, not only the bloodiest dictator in all Latin America but also reputedly a voodoo priest. Both 4VU and 4VEH, in contrast, are Christian missionary stations. Despite their differences, all three have gotten along together very well during the past few years with one major exception.

But let's start at the beginning—with 4VB. This one has become famous for French and Creole folk songs praising Papa Doc, on-the-spot broadcasts of "live" executions, and constantly switching frequencies. However, during an unsuccessful invasion of the republic (apparently launched from the Bahamas) on May 20, 1968, *La Voix* appeared on 6103 kHz. It has since varied not more than a few kHz from that spot, though it is logged outside Haiti only on rare occasions. Explanation is an erratic and short schedule. When it is on, 4VB's sign-off often comes as early as 1800 EST (which is around sunset in Port-au-Prince).

In fact, with the exception of those two missionary stations (both financed and controlled by non-Haitians), all Haitian broadcast activities have steadily declined

by C. M. Stanbury, II

VOODOO RADIO

since 1968. But this of course makes Haitian loggings all the rarer.

Rebel Radio. Prior to the attempted invasion, R. New York Worldwide aired a series of rebel programs to Haiti in French and Creole under the alias *La Voix de l'Union Haitienne Internationale* (0600-0630 EST on 15265 kHz). The broadcasts continued for a time even after the invaders had been routed, though there was some jamming, presumably from 4VB, in the form of distorted Latin American music.

A few months after this counter broadcasting commenced, the rebel programs from R. New York Worldwide ceased. Whether this was due to the jamming, the general stagnation in Haitian broadcasting, or an overall reduction in Caribbean clandestine radio activities remains to be seen. In any event, 4VB does go down in history as perhaps the only Latin American broadcast station outside of Cuba to ever be used as a deliberate jammer.

As for the four privately owned (commercial) Haitian stations currently active on the SWBC bands, they, like 4VB, seem to also be on reduced schedules with only limited nighttime broadcasts. (See our chart for details on call letters, frequencies, etc.) At last check, however, all four were verifying those few DX reports they do receive.

Station 4VEH. It was also the Bahaman-based invasion that caused the one brief rift between Papa Doc and those missionary stations or, to be more precise, between the Port-au-Prince government and 4VEH at Cap-Haitien. Because of their Bahaman starting point, the invaders landed in North-west Haiti, very close to Cap-Haitien.

S&E'S GUIDE TO VOODOO RADIO

kHz	Call	Station	Location	Time (EST)
1035	4VEF	"4VEH"	Cap-Haitien	0500, 2000
1145	4VAB	R.Caraibes	Port-au-Prince	1900- 2000
2410	4VU	R.Lumière	Les Cayes	0500, evening
2450	4VSO	"4VEH"	Cap-Haitien	0500, 2000
4940	4VM	Radiodiffusion Haitienne	Port-au-Prince	0600
5040		R.Valparaiso	Port-de-Paix	1900- 2000
6035	4VAB	R.Caraibes	Port-au-Prince	1900- 2000
6103	4VB	La Voix de la Révolution Duvaliériste	Port-au-Prince	1800
6195	4VHW	R.Haiti	Port-au-Prince	0600
9770	4VEH	"4VEH"	Cap-Haitien	0700, 1830
11835	4VEJ	"4VEH"	Cap-Haitien	0700, 1830

Though monitoring reports (on 6120 kHz) indicated that 4VEH carried on with normal programming during this conflict, Papa Doc decided that 4VEH had somehow helped the invaders and put them off the air for a time. However in a month or so the "misunderstanding" was resolved and 4VEH returned to the air.

While 4VEH at times enjoys a worldwide audience on such frequencies as 9770 and 11835 kHz, in the U.S. and Canada it's more easily heard on 1035 kHz in the standard BCB and 2450 kHz in 120-Meter territory. Best time to try for either of these channels is at 0500 sign-on and again around 2000 EST. It should be noted that while the whole Cap-Haitien operation is known as 4VEH, each transmitter is also assigned its own set of call letters. For example, the rig on 2450 kHz identifies as 4VSO, while the one on 1035 is known as 4VEF.

(Continued on page 96)

En confirmación y con aprecio por su atento reporte de recepción de la Radio Difusora **4VEH**

APARTADO 1. CARO HAITIANO, REPUBLICA DE HAITI.

"Voz Evangelica de Haiti"

BANDA DE 31 METROS 3000 WATTS

El principio de tus palabras alumbra; hace entender a los simples. — SALMO 119

QSL from Haitian station 4VEH, transmitting in 31-Meter band. Station calls itself the evangelical voice of Haiti; card contains quote (in Spanish) from Psalm 119.

All-Solid-state IC LOW BANDER

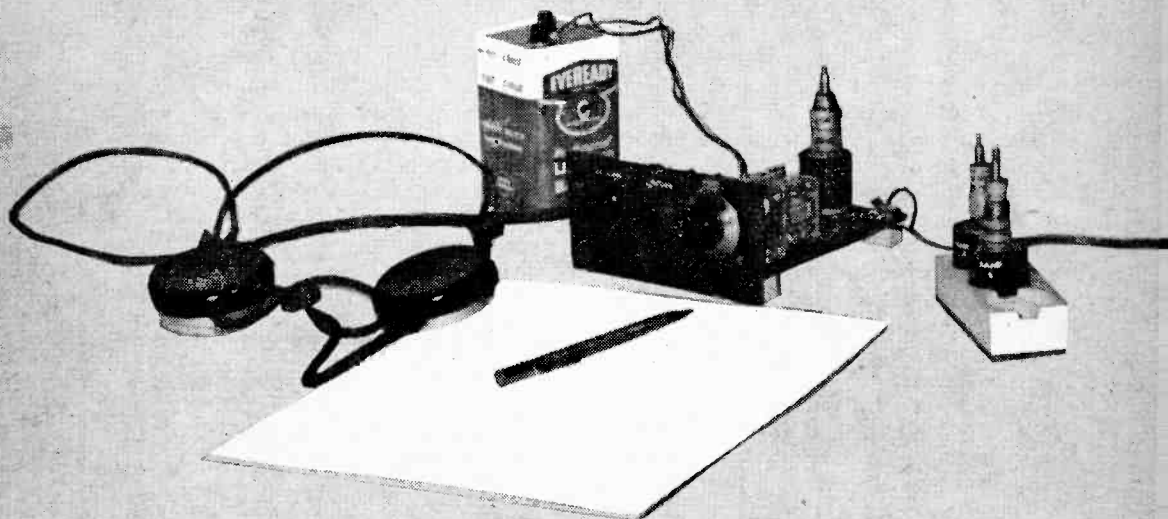

Dip all the way down to a low, low 80 kHz with a regen receiver that's as mod as its IC innards!

by Charles Green W6FFQ

FROM the earliest days of radio the long wave band of the spectrum has been used for weather forecasts, naval and commercial CW communications, and aircraft beacons. Since many CW transmissions in the LF band are hand-keyed, listening to them is an ideal way to improve your ability to copy CW. SWLs can find a new interest in logging aircraft beacons and other LF stations.

Our easy-to-build, integrated circuit (IC), low frequency (LF), regen receiver tunes from 80 kHz to 420 kHz covering the most active portion of the long-wave band. Two plug-in coils cover the span of LF frequencies; a third plug-in coil covers the standard BCB to provide a dual-purpose receiver.

The output of this all-solid-state receiver is of sufficient level to drive either high- or low-impedance headphones or a small speaker. Construction has been simplified and the 6-volt lantern-type battery provides power for a long period of oper-

LOW BANDER

ating time before requiring replacement.

How It Works. Signals gathered by the antenna are fed to the receiver via input jack J1 to the primary winding of L1, the plug-in coil. The secondary of this coil is tuned by C2 and coupled to the input of one half of IC1 via C3. The signal is detected and fed to the input on the second half of IC1 via C6. Regeneration is effected through the tickler winding via C4 by feeding a portion of the signal being amplified in the first half of IC1, taken off at interstage pin 4. Potentiometer R1 is shunted across the tickler and limits the amount of signal fed back into the tickler.

The resulting signals from the first half of the IC are coupled as audio signals to the second half of the IC via C6 and gain control R3, where they are amplified further to drive output power transistor Q1. Output of Q1, which is a low-impedance transistor, will match speakers of 8 to 45 ohms or low- or high-impedance headphones without matching transformer.

We've powered the IC/Vamp LF receiver from a 6-volt lantern type battery that has a greater current output capacity than D or A cells, and therefore will operate the receiver for longer periods of time before having to be replaced. Diode D1 has been included to protect the IC and transistor Q1 from damage that could occur if battery polarity should accidentally be reversed. If by chance you have an AC-operated power supply that will deliver 6 volts regulated output, it can be used in place of the battery specified.

Building It. Since LF circuits are notably unsusceptible to stray capacitance and leakage that may be created by interconnect-

In making coils detailed here, remember all windings run in same direction.

ing leads, our IC/Vamp LF receiver isn't critical to physical layout. You should, however, employ normal good wiring practices in building it. We suggest you follow our layout as shown in the photos to simplify construction.

All components, except for tuning capacitor C2, audio level control R3, regeneration control R1, and the socket for plug-in coil L1, are mounted on a 2 1/8 x 2 3/4-in. piece of perfboard. We used push pins to provide easy soldering of connections as well as for better mounting support plus a means to allow easy replacement of a part should it become necessary. The chassis base and front panel are made from 1/8-in. thick tempered hardboard (Masonite).

Wooden blocks, 1/2-in. square running full width, are cemented to the front and rear edges on the bottom of the main chassis hardboard sheet. These serve as feet to raise the entire assembly. Exact dimensions for the hardboard chassis base and front panel are given in the Parts List.

After drilling the front-panel holes for mounting R1, R3, and the tuning dial,

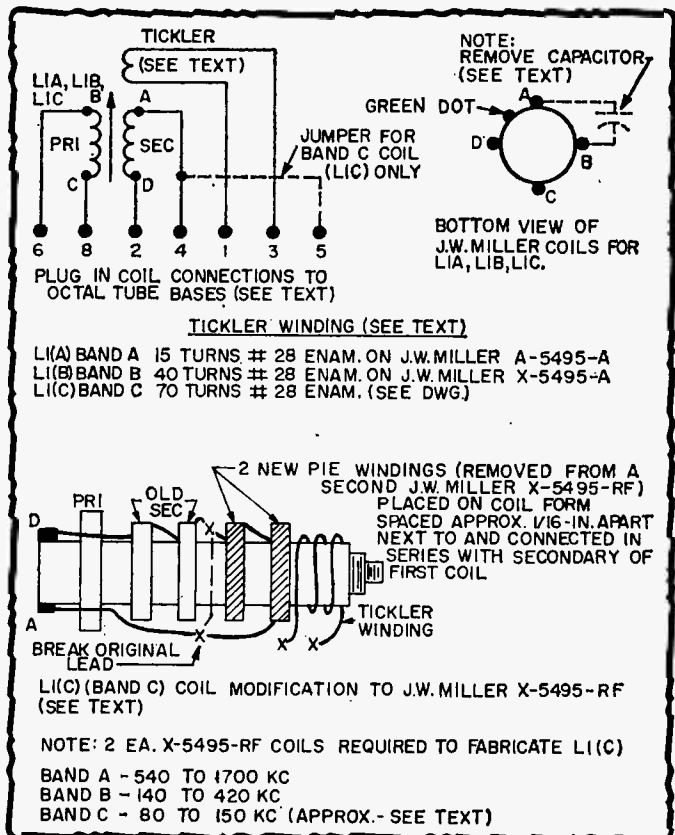

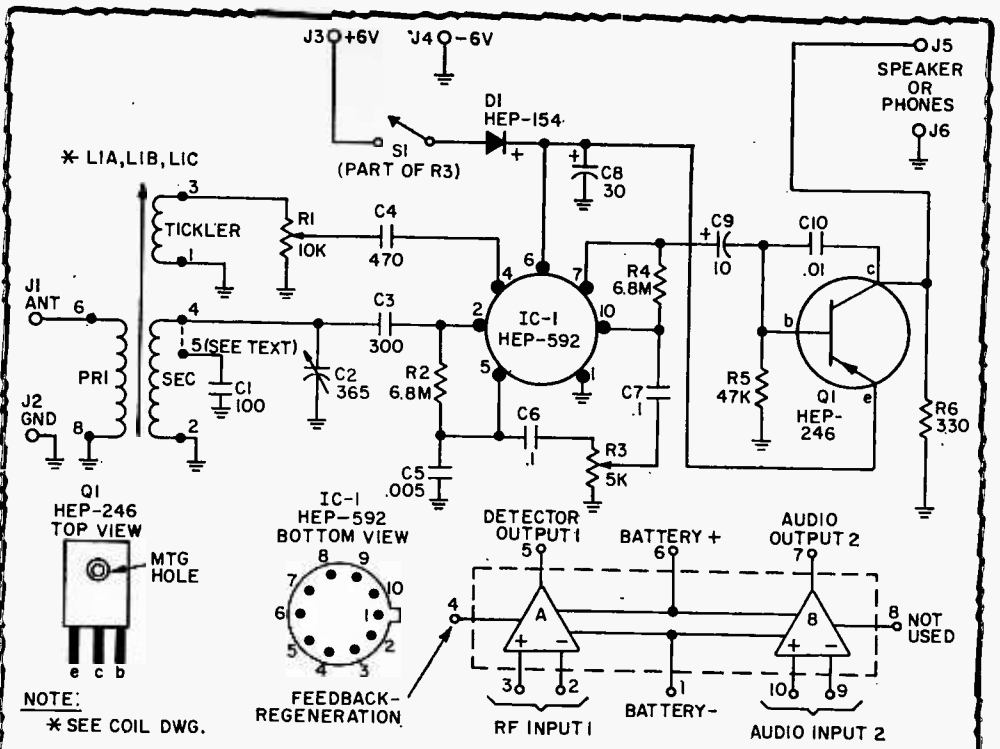

NOTE:
* SEE COIL DWG.

IC/VAMP LF RECEIVER PARTS LIST

- B1—6-V lantern battery (Eveready 510 S or equiv.)
- C1—100-pF, 75-V ceramic capacitor (Lafayette 33E69022 or equiv.)
- C2—365-pF variable capacitor (J.W. Miller 2111 or equiv.)
- C3—300-pF, 150-V ceramic capacitor (Lafayette 33E21791 or equiv.)
- C4—470-pF, 1000-V ceramic capacitor (Lafayette 32E01779 or equiv.)
- C5—0.005-uF, 75-V ceramic capacitor (Lafayette 33E69048 or equiv.)
- C6 C7—0.1-uF, 75-V ceramic capacitor (Lafayette 33E69089 or equiv.)
- C8—30-uF, 16-V electrolytic capacitor (Lafayette 34E85505 or equiv.)
- C9—10-uF, 16-V electrolytic capacitor (Lafayette 34E85463 or equiv.)
- C10—0.01-uF, 75-V ceramic capacitor (Lafayette 33E69055 or equiv.)
- D1—50-PIV, 1-A silicon diode (Motorola HEP-154)
- IC1—Dual integrated circuit (Motorola HEP-592)
- J1, J2, J3, J4, J5, J6—Fahenstock clips (Lafayette 33E71028 or equiv.)
- L1A—540-1700 kHz coil (J.W. Miller A-5495-A antenna coil)
- L1B—140-420 kHz coil (J.W. Miller X-5495-A antenna coil)
- L1C—80-150 kHz coil (fabricated from 2 coils, J.W. Miller X-5495-RF—see text)
- Q1—Pnp silicon transistor (Motorola HEP-246)
- R1—10,000-ohm, linear taper potentiometer (Lafayette 33E12626 or equiv.)
- R2, R4—6.8 megohm, 1/2-watt resistor
- R3—5000-ohm, audio taper potentiometer AF gain control with spst switch S1 (Lafayette 32E22510 or equiv.)
- R5—47,000-ohm, 1/2-watt resistor
- R6—330-ohm, 1/2-watt resistor
- S1—Spst switch (part of R3)
- S01—Octal saddle socket for plug-in coils (Lafayette 32E20951 or equiv.)
- 1—1 1/2-in. dia. vernier dial (Lafayette 99E60311 or equiv.)
- 1—5 x 5 x 1/8-in. piece tempered hardboard (Masonite or equiv.)
- 1—5 x 2 1/2 x 1/8-in. piece tempered hardboard (Masonite or equiv.)
- 1—1 1/2 x 2 x 1/16-in. sheet aluminum for bracket
- 1—2 3/4 x 2 3/16-in. piece perfboard for circuit board (Lafayette 19E83139 or equiv.)
- Misc.—Knobs, perfboard and push-in terminals, 1/4-in. spacers, 1/2-in. square wood strips, solder lugs, plastic sleeving, hookup wire, hardware, octal tube bases for plug-in coils, rub-on letters (Datak or equiv.) etc.

mount the dial on it. Next drill holes in the chassis base for mounting the plug-in socket for L1, the perfboard and antenna, battery and speaker terminals. Then cement the wooden blocks to the bottom of the chassis

and cement the front panel to the wooden block on the front edge.

Put this aside to allow the cement to dry and make a 1 1/2 x 1 1/2-in. mounting bracket from scrap aluminum with a 1/2-in. foot,

LOW BANDER

bent at a right angle to the main support. Drill the bracket to fix mounting holes on the front of C2 and the holes in the 1/2-in. foot, to match those drilled in the chassis base for mounting the bracket. Make holes in the foot oversized to allow slight alignment adjustments to ensure freedom of dial rotation when tuning capacitor is fastened to dial.

When cement has thoroughly dried, mount the capacitor loosely to the chassis and tighten set screw locking capacitor shaft to dial drive. Rotate dial through its complete excursion to check for binding. If satisfactory, tighten bracket to chassis.

If cement requires more drying time, go on to the perfboard assembly before adjusting dial and tuning capacitor positioning. Insert push pins as shown in photos, mount parts on them, and solder them in place. Great care should be taken not to apply too much heat to the leads of IC1 and Q1. We suggest you use an alligator clip on each of the leads of the solid-state units to act as a heat sink while soldering these units onto the perfboard. The IC is sunk into a hole in the perfboard, bottom-side up, with its leads fanned out to surrounding push pins.

Except for Q1, which is fastened top-side down with a short bolt and nut that also acts as a heat sink, all parts are self-supporting on their leads. Interconnecting leads should be as short and direct as possible. You may want to place them on the bottom of the perfboard and solder to tabs of the push pins. This makes a neat sub-assembly.

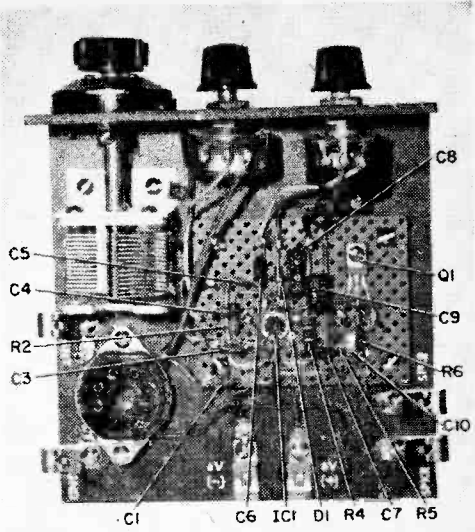

This bird's eye view shows where all parts are located on perfboard. Base connections for IC1 and Q1 are shown in schematic.

Use 1/4-in. spacers to raise the perfboard from the chassis base and 1/2-in. spacers to raise the socket for L1. You may have to bend or cut off some part of the socket lugs to keep socket clearance within the 1/2-in. spacing afforded by its mounting spacers.

Be a Coil Maker. The only construction work left is the making of the plug-in coil L1 [there are actually three—L1 (A), L1 (B), and L1 (C)]. Coils are fabricated from standard commercially-wound coils to which tickler windings are added by slipping them over the top of the coil form. Tickler for coil L1 (A) covering the BCB (540 to 1700 kHz) is 15 turns of #28 enameled

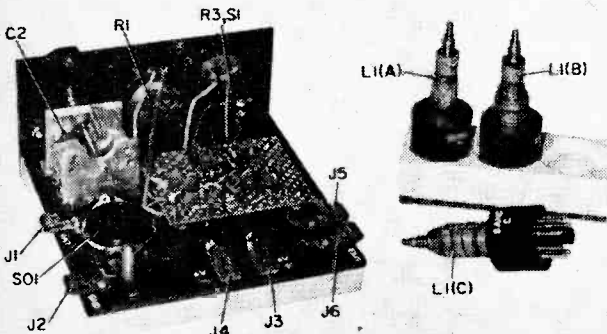

In addition to showing neat coil rack described in text, we've located all other parts not mounted on perfboard. Though layout isn't critical this one conserves space and makes for an efficient low-band receiver, so why not use it? You'll be pleasantly surprised at how well it works.

wire wound in the same direction as the other windings of the coil. Coil L1 (B) (140 to 420 kHz) tickler is 40 turns of #28 enameled wire, added with same precautions on direction of winding mentioned above.

Coil L1 (C) has other modifications in addition to the tickler, which, in this case, is 70 turns of #28 enameled wire. You'll need two of the Miller X-5495A RF coils specified in the Parts List. The second one is your source of supply for the two additional pi-windings needed to modify the coil you must fabricate for L1 (C). Be sure the additional windings are added so that the direction of the turns is the same for the additional windings as are the windings of the coil being modified. This same caution should be heeded for the tickler coils you'll wind for these coils.

One other modification is required: remove the capacitor installed by the manufacturer between connections A and B on each of the coils. Also, on L1 (C) *only*, add a jumper from pin 4 to pin 5 on the octal tube base in which the coil is mounted. Adjust all coil alignment screws so that they extend about 1/4-in. above the top of the coil form.

All three coils are each mounted in a separate octal tube base to facilitate plugging them into the receiver. Solder heavy bare copper wire to each of the coil's connectors, leaving the wires long enough to extend through relevant tube base pins. After

soldering them to the coil, insert these wires in their respective pins in the base and push this coil assembly as far down into the base as possible to ensure a rugged coil mount.

Clean out all old cement and pieces of glass from the tube base, and clear all of the pins of solder. When a coil has been properly placed in its tube base, solder the lead wires to the tube pins and cut off excess lead wire and solder so that the completed assembly can be easily inserted in an octal socket. See details on the coil modifications in the accompanying drawing.

You may want to make the attractive, useful stand shown in the photo to hold the plug-in coils when not in use. It's easy to make. Drill three holes, 3/4-in. in diameter, in a 1 1/2 x 3 7/8 x 3/4-in. wood block and countersink them to a depth of 1/4-in. with a 1 1/8-in. diameter hole. Cement a piece of 1/8-in. hardboard over side not countersunk and you have your coil stand. You may have to ream the holes slightly if the coils fit too snugly.

Checkout and Operation. Before connecting the battery, check all wiring and double check for correct polarity of diode and electrolytic capacitors. One thing to bear in mind is that for best LF reception you need a long antenna mounted as high as possible. The exact length isn't nearly as critical for LF reception as for uhf and vhf reception. Also, for best reception you need a good

(Continued on page 98)

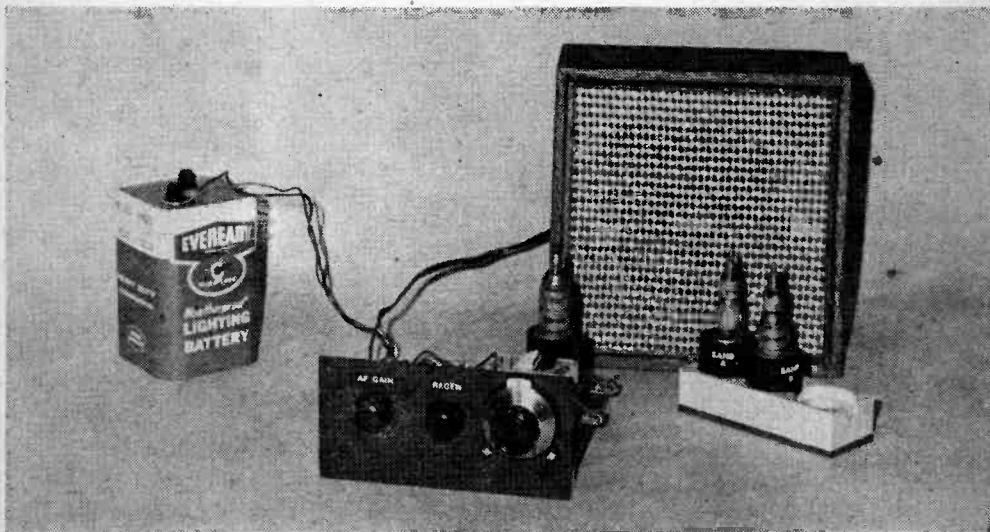

From opening photo and a quick glance at schematic you might guess the Low Bander will only operate phones. Actually we drove speaker at a fair audio level.

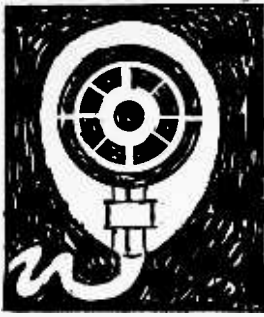

HAM TRAFFIC DE W7DQS

by MARSHALL LINCOLN

The Noose Is Getting Tighter

WHEN you sit down to your ham rig for an evening of operating, do you now get the feeling that there's a loop of rope around your neck, and somebody far away is pulling on it?

I sure do, especially after our "friends" on the Potomac, the good ol' Friendly Candy Company, dropped one of the biggest bombshells of the century on the whole radio industry, including ham radio. Then they followed it up with a second attack aimed specifically at certain ham radio technical advancements.

The big blast, as you probably realized, was the new super stupendous increase in license charges. The second blast was one which has gone unnoticed by everyone except one particular group of hams involved—and they're boiling mad, with good reason, for it betrays much they have accomplished in recent years while the FCC was setting on its thumbs.

To take first things first, the new schedule of license charges, and the so-called "reasoning" behind them, reads like something right out of the secret files of a power-mad dictator. Most hams probably aren't aware of the whole scheme which the FCC has hatched up, and so they don't realize what a monster is breathing fire down our necks. They are inclined to think of the \$9.00 charge for a ham license application or renewal as an irritation, but little more.

However, the implications of the new set of FCC charges which covers the industry like a cast-iron bed sheet present a real threat to hams. Anything which restricts the electronic industry has side effects which hurt ham radio, and these new license charges will restrict the electronics industry—and threaten its future—like a gang of

Chicago hoodlums turned loose at a ladies garden party.

Arrogant and Defiant. If you can get hold of a copy of the full FCC proposal, which touches all facets of radio and TV activity, and study it in detail, you will come right up out of your chair and go through the roof. You will be downright stunned by the arrogant, defiant attitude toward all radio communications activity displayed in this barrage of bilge known officially as Docket 18802, Notice of Proposed Rule Making.

To get the full impact of what the Feds are doing to us, we must briefly review what has happened.

Back in 1963, the FCC concocted a schedule of charges for various licenses. Before that, there was no charge for ham tickets, commercial operator's licenses, and pilot's radio licenses, among many others. The FCC always has called these "license fees," but I maintain they actually are additional TAXES. The Feds don't like to hear that word, because there's a little item in the U. S. Constitution that says only Congress can levy taxes, and these license charges certainly didn't come from Congress.

Object of the original set of license charges was to recover part of the cost of operating the FCC from the individuals, groups and industries which use the FCC's services, rather than have all taxpayers foot the entire bill. There are arguments you can make on both sides of that issue, but the Feds only listened to the arguments which supported their side.

Two Big Flaws. The original set of license charges might not have been so bad, except for two items: First, the money paid for radio licenses does not go into the FCC's operating budget. Rather, the FCC deposits

this money in the U. S. Treasury general fund. Then the FCC goes to Congress each year to ask for whatever money it feels it needs to operate. There has been no indication that the amount of money paid each year by all types of radiomen ever was considered in setting the FCC budget.

And second, the license charges have no relationship to the amount of work the FCC does in each radio service. For example, it seems to me that if hams pay in a certain amount of money for their licenses, they are entitled to have a proportionate amount of the FCC's time and energy spent on services for hams, such as license exams and monitoring and enforcement efforts. Has this been done? Haw—in a pig's eye!

So, you see the original license charges were merely a scheme for the Federal gov-

ernment to collect additional money from the electronics industry, both hobby and professional. The entire cost of operating the FCC still is paid by that good ol' No. 1 sucker, the U. S. taxpayer.

Now, though, after having gotten away with this racket for nearly seven years, Uncle has hatched a new scheme, and it's a dilly! The idea now is to collect the *entire* cost of operating the FCC from the radio and TV industry! And the way they decided to do it is really a hair-raiser!

FCC "Work" Doesn't Count. The new charges are not based basically on the amount of work which the FCC would spend on that particular type of radio service, but rather on the "value to the user" of that type of radio usage! In other

(Continued on page 99)

More From Heathkit's HW-16 Novice Transceiver

When it first appeared, the Heathkit HW-16 novice CW transceiver was described in Ham Traffic as a handy and well-designed piece of gear for the beginning ham. That's still true, but there're a few modifications you can make to improve it still more. First, rewire the audio output connections so they are hooked up as shown in this wiring diagram. This will allow you to have full audio volume in your headphones, no matter whether you have a speaker plugged in. When wired according to Heath's directions, you lose audio in your phones unless you have a speaker connected, even though the speaker is muted. Second, after you get your general ticket, you'll want to do most of your transmitting on the same frequency as

the station you're working, so disconnect one lead of the neon bulb used in the oscillator which provides the keyed tone in the receiver when you're sending (see photo). This will allow you to hear your own transmitted note in the receiver, which always is good CW operating practice. The neon bulb oscillator is handy when working as a novice, because you often must transmit on a frequency different from the station you're working, but after that is over, it can be a nuisance. By leaving one of the bulb's leads connected, you can easily restore the neon bulb oscillator if you want to. You'll also find it handy to remove and discard the RCA phono jack used for an antenna connector, and replace it with a conventional SO-239-

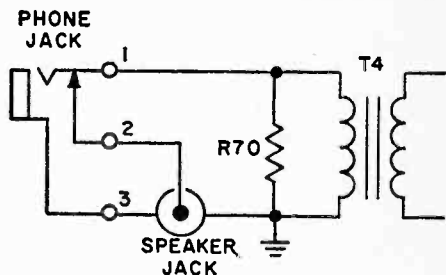
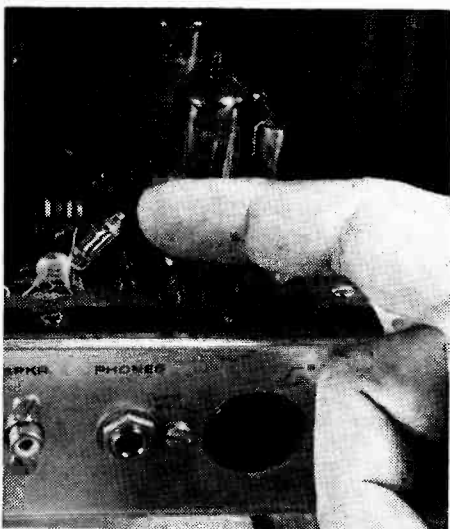

type female coax connector, which will match the standard coax plugs ordinarily used for antenna feed lines. Also, adding a metal panel, drilled with lots of small holes for ventilation, to cover the open back of the cabinet would be a good idea, for safety, for RF shielding, for protection of the exposed components, and to keep out at least a little dust. Drill holes in the flange around the rear of the cabinet, and attach the rear panel with sheet metal screws.

VT Control

Below—here's television timer in all its glory. Parents are sure to lock it 'n' pocket key.

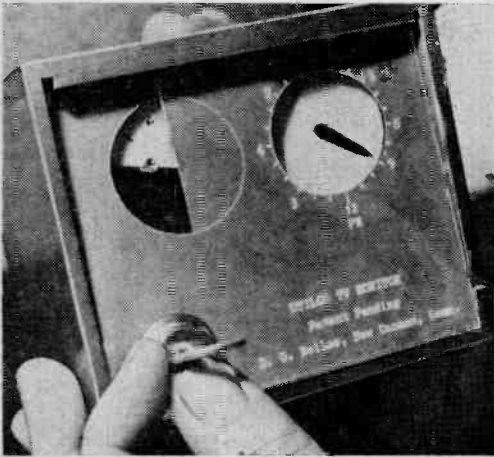

Father informs his prepossessed offspring that there will be no daddling with timer. But kids seem unaware of him.

THE Pied Piper of Hamelin burst upon America's living-room scene some 22 years ago, tootling his fantasy song loudest to the family's young. To this day his loyal following still hums his tune with glassy-eyed attention.

Saturday morning activity around your home tells our tale. You're sure to see the brood plopped before the boob tube fantasizing along with, say, animated gorillas saving the whole world from lesser animal life. And every seven minutes, when this glass-and-aquadag Pied Piper clobbers your kiddies with hard-sell, watch as they mimic the barker down to his very convincing . . . "be the first on your block!!" routine. Certainly the TV doesn't influence a young person during all of his daily activities, but its opiate effect is clearly mirrored in him as he passes through a store and spies a product heavily hawked in his direction.

for BT Addicts

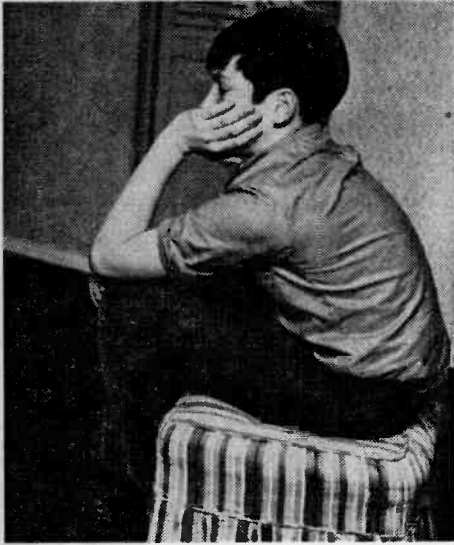

Left—engaged with TV's afternoon academe, young folk mime Rodin's *The Thinker*. Bottom—timer top hides TV plug.

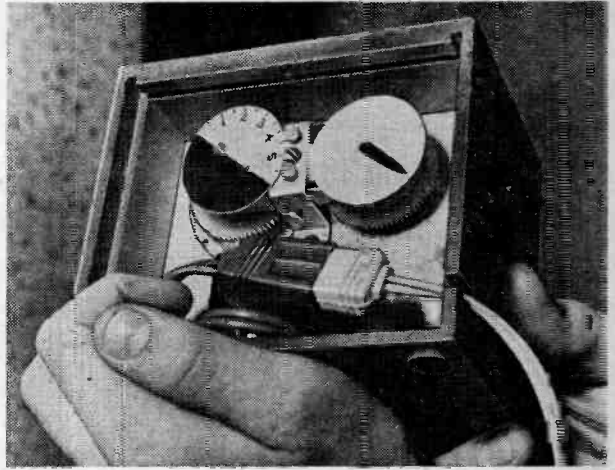

Television addiction worries many parents. They now believe that the answer lies in a little black box which sits atop the TV set. D. G. Noiles, an enterprising mechanical engineer living in Connecticut, set upon his Yankee ingenuity to try his hand at correcting the nationwide Johnny-sits-'n'-stares problem. He concluded that the amount of time a child spends before the TV can be pre-decided by parents and controlled automatically by his device.

The TV's wired into the box, set for the specified amount of viewing time, then locked. When your little bugger's viewing time has been used up, the monitor will switch off the set, and it can't go on again until the next day. The idea, if not new, is certainly novel. As the box forces the child to improve his viewing discretion, he'll need less View Time control for Boob Tube addiction. ■



Dad holds key to TV timer. Little miss's miffed 'cause now she's got more time for homework, other un-TV doings.

Repairing or refinishing any kind of furniture ?

1. You need *The Furniture Doctor* — George Grotz's famous, encyclopedic compendium of practical information . . . with easy-to-follow directions and tricks of the trade that use commonly available materials . . . all presented with more than 90 illustrations and the author's usual hilarious anecdotes in the Yankee manner! Hardcover, \$5.95



32 easy ways to get out of refinishing ?

4. You'll find them in *Decorating Furniture with a Little Bit of Class*, together with some cheap ways to furnish an apartment in a hurry out of a Goodwill store, a Salvation Army emporium, or a St. Vincent de Paul Society; faking techniques; lazy man's tricks of the trade; and some extra stuff thrown in. \$1.95



Want to refinish the quick and easy way ?

2. *Instant Furniture Refinishing and Other Crafty Practices* is for you. It's newer and bigger than Grotz's own *From Gunk to Glow* — with professional trade "recipes" organized for amateur craftsmen, including how to get a "new look" without refinishing; how to remove paint cheaply and easily; how to "antique." \$1.95



Looking for antiques in the middle-price-range ?

5. *Antiques You Can Decorate With* is the Furniture Doctor's own practical, Yankee-shrewd guide to what they are, where to find them, how much to pay for them, how to refinish, and how to avoid fakes. With 400 drawings that cover the whole gamut of old pieces, from beds to wall things. Hardcover, \$4.95



Staining, shellacking, varnishing or waxing ?

3. Using bleach, linseed, lemon oil, or polish? Grotz's *Staining and Finishing Unfinished Furniture and Other Naked Woods* is the one eye-opening, pioneering manual that tells the truth about using them all — which to use, when, how to prepare surfaces, and how always to get that expensive, quality, finished look. \$1.95

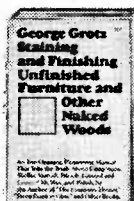

In the market for Victorian furniture ?

6. *The New Antiques: Knowing and Buying Victorian Furniture* is the one, up-to-date, illustrated guide that will help you identify, appraise, and refinish American Victorian furniture. Covers Gothic, Renaissance, Art Nouveau, all other important styles. Includes up-to-date Price Guide on all pieces. Hardcover, \$5.95



THE FURNITURE DOCTOR HAS THE ANSWERS!



Molly Malone Cook

— — — MONEY-BACK GUARANTEE! — — —

Science & Mechanics Book Club
DI-106
229 Park Avenue South, N.Y., N.Y. 10003

Please send me the books by George Grotz, the Furniture Doctor, checked below. I'm enclosing my check or money order for the price of the books (plus 25¢ shipping charge if my order totals less than \$4.95). I understand I may return book(s) ordered within two weeks for a full refund if not completely satisfied.

1. (\$5.95) 2. (\$1.95) 3. (\$1.95)
 4. (\$1.95) 5. (\$4.95) 6. (\$5.95)

NAME.....

ADDRESS.....

CITY.....STATE.....ZIP.....

Offer available in U.S. only.

10 Reasons why RCA Home Training is

your best investment for a rewarding career in electronics:

Transistor experiments
on programmed breadboard—
using oscilloscope.



1 LEADER IN ELECTRONICS TRAINING

RCA stands for dependability, integrity and pioneering scientific advances. For over a half century, RCA Institutes, Inc., has been a leader in technical training.

2 RCA AUTOTEXT TEACHES ELECTRONICS FASTER, EASIER

Beginner or refresher — AUTOTEXT, RCA Institutes' own method of Home Training will help you learn electronics faster, easier, almost automatically.

3 THOUSANDS OF WELL PAID JOBS ARE OPEN NOW

RCA Institutes can help you qualify for a rewarding career if you have an interest in electronics. Every year, thousands of well paid electronics jobs go unfilled just because not enough men take the opportunity to train themselves for these openings.

4 WIDE CHOICE OF CAREER PROGRAMS

Select from a wide choice of courses and career programs ranging from basic Electronics Fundamentals to advanced training including Computer Programming and Electronics Drafting. Each

Career Program begins with the amazing AUTOTEXT method.

5 SPECIALIZED ADVANCED TRAINING

For those working in electronics or with previous training, RCA Institutes offers advanced courses. Start on a higher level. No wasted time on material you already know.

6 PERSONAL SUPERVISION THROUGHOUT

All during your program of home study, your training is supervised by RCA Institutes experts who become personally involved in your efforts and help you over any "rough spots" that may develop.

7 VARIETY OF KITS, YOURS TO KEEP

At no extra cost, a variety of valuable specially engineered kits come with your program—yours to keep and use on the job.

8 TRANSISTORIZED TV KIT AND VALUABLE OSCILLOSCOPE

You will receive in most career programs a valuable oscilloscope. Those enrolled in the TV Program or courses receive the all-new Transistorized TV Receiver—exclusive with RCA. Both are at no extra cost.

9 TWO CONVENIENT PAYMENT PLANS

Pay for lessons as you order them. No contract obligating you to continue the course. Or, you can take advantage of RCA's convenient monthly payment plan.

10 RCA GRADUATES GET TOP RECOGNITION

Thousands of graduates of RCA Institutes are now working for leaders in the electronics field; many others have their own profitable businesses... proof of the high quality of RCA Institutes training.

RCA INSTITUTES, INC.

Dept. 764-008-0, 320 West 31st St., N.Y., N.Y. 10001

Canadians: These same RCA courses are available to you in Canada. No postage. No customs. No delay. Your inquiry will be referred to our school in Canada.

All courses and programs approved for veterans under new G.I. Bill.

CLASSROOM TRAINING ALSO AVAILABLE. FREE CATALOG ON REQUEST.

ACCREDITED MEMBER National Home Study Council

Construction of Oscilloscope.

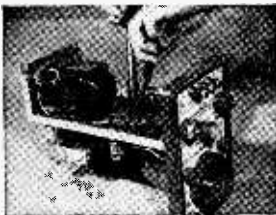

Construction of Multimeter.



If Reply Card is Detached—Send This Coupon Today

RCA INSTITUTES, INC.

Home Study Dept. 764-008-0
320 West 31st Street
New York, N.Y. 10001

Name _____

Address _____

City _____

State _____ Zip _____

Check here if interested in Classroom Training

ER, 1970

I must go down to the sea again, the dirty polluted sea!



THE quiet atmosphere that reigns at the Long Island University's Mitchel Campus Marine Laboratory located in East Meadow, New York, would never suggest the important work in oceanography that goes on there, and how the future of our existence depends on what studies and results will be found there. Nor does the public know how important every trip is that the little Lucayo, the lab's oceangoing 56-foot research ship makes, as it slips quietly out of its berth at Oyster Bay. The 29-ton vessel collects data and samples on the marine life that surrounds the area.

We are all becoming aware of the dangers of water pollution. Many rivers and



Aboard the Long Island University's Marine Science Boat Lucayo scientists check the offshore waters near Oyster Bay, Long Island. The ship, built as a charter vessel for Bahama Island hopping, was donated to the Marine School for research purposes. With diesel engine and sail, this little craft is ideal for cruising close to shore or for deep-water testing. Prof. Uzzo (right) prepares a device for sampling water at shallow depths. Called the Van Dorn water sampler, it is one of the most frequently used instruments in marine biological studies. A student (left) aboard the Lucayo reads and records temperatures of water samples taken at the surface and at various depths. Measurements are very critical because water pressure below surface must be compensated for, or readings are meaningless.





lakes now beyond the pollution stage and entering the poisonous stage are infecting the sea and its waterways and bays. The marine organisms (nekton, plankton, and benthos), those that swim, float, and those that live on the bottom of the water, are slowly being poisoned by man.

The average person gives little thought to how important sea and other water life is to our survival. Taking for granted all that comes from the sea, there is small concern about when it may run out. Man pours waste into the rivers and lakes, polluting the main arteries of the ocean and some day will kill every living creature in the sea. It may seem impossible now, but there are

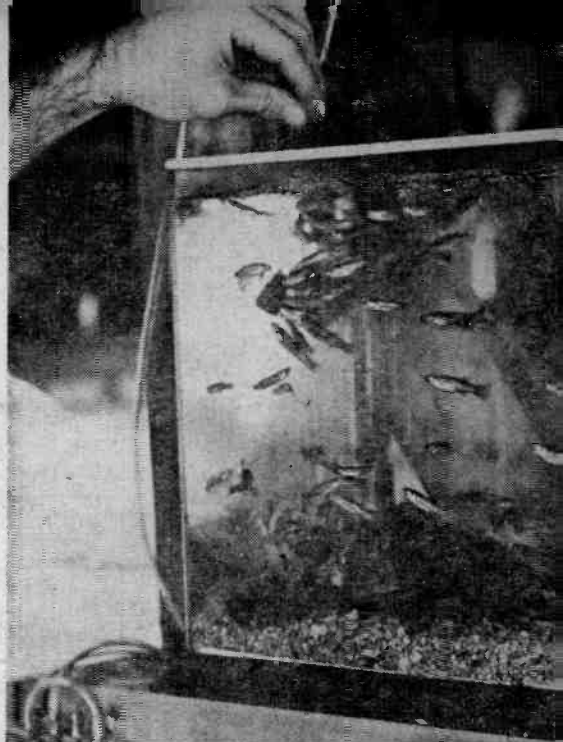

It is important to maintain sea conditions in the laboratory while investigating fish and performing experiments. Here, a marine scientist takes the water temperature of one of the experimental tanks. Their rigid control techniques make amateur aquarium purification practices seem very crude.



Dr. Masaru Fukiya (above and right) is a scientist from Japan, visiting the Mitchel Lab. In a way he is close to home since he uses a Sony tape recorder and other electronic equipment to study the behavior of fish that have minute electrodes attached to their body surfaces and fins.

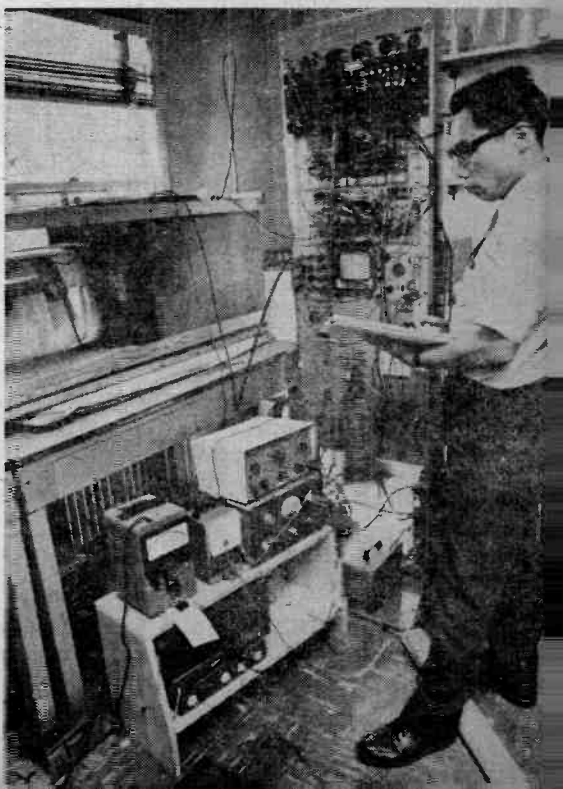

polluted sea!



One way to check marine growth is to use radioactive "tags" in the food cycle. Then, electronic circuits measure isotope emissions.

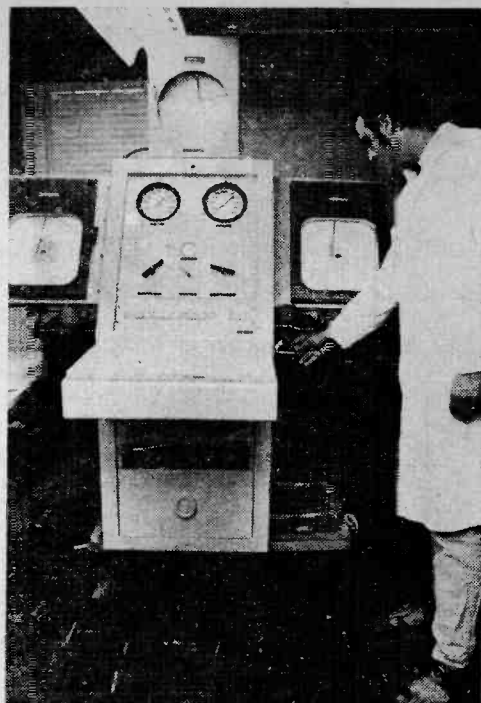

At the lab a student performs simulated deep sea experiments up to 3000-ft depths. The control panel looks like NASA designed it.

lakes and rivers that are not only uninhabitable for fish and marine life, but even man cannot go near them for fear of being poisoned. As one graduate student put it, "The sea was once thought to be the future conveyor of the needs of our growing population, but now it is no longer what potential the-sea may have for the future, but saving

what is left from destruction."

Here at the Mitchel Field Lab students and scientists are doing what they can to prevent our age from being robbed of the riches that lie in the treasure houses of the waters around this planet. But they will also need the help of an aware public as well as more funds. ■

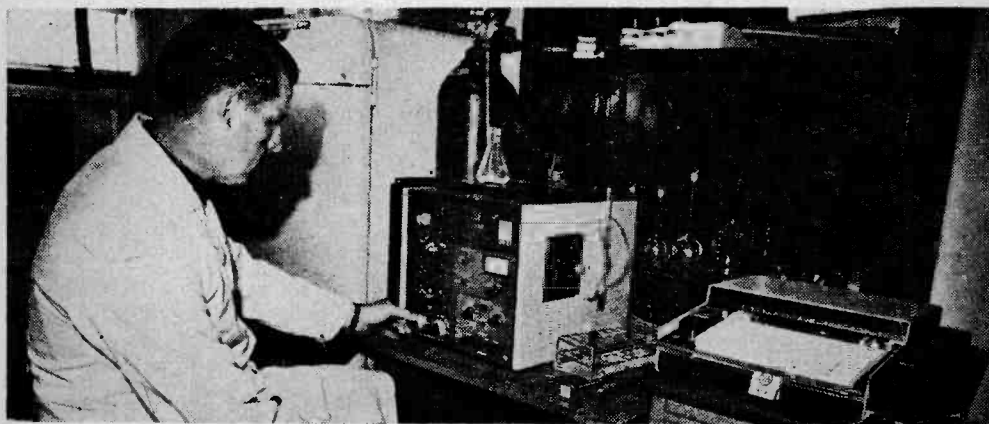

One of the scientists at the Marine Lab operates a gas chromatography instrument that can be used to identify many of the insecticides that pollute our waterways and

Flash Switch

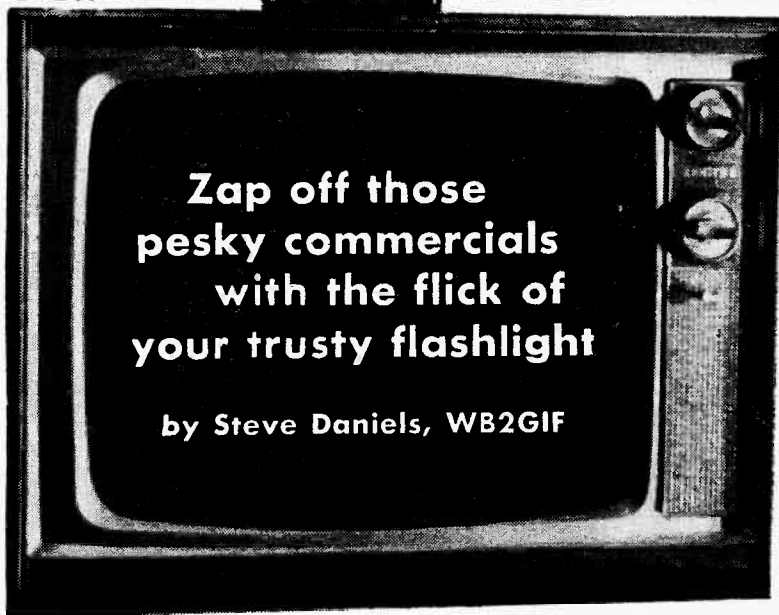

Are you one of the multitude of TV listeners and lookers who's ready to reach for a baseball bat every time your intelligence is insulted by one of those great commercials conceived by the Madison Avenue Boys? Do you suffer whenever you're told that Ultra Swipe Toothpaste gives you sex appeal? Have you had your fill of White Knights, White Tornadoes, and White Enzymes? Then you're ready and eager to use our *FlashSwitch*.

What is it? A solid-state switcher that lets you relax in your favorite easy chair and, with the flick of a flashlight, silence your set whenever an offending commercial starts to sound off. A second flash restores the program when you're ready to listen again. Sure, over the years a number of different types of sound silencers, or commercial silencers, if you prefer, have been foisted on the TVviewer. But then, we're all interested in applying and trying new circuits and ideas.

In poring over the latest Radio Shack catalog recently we ran across their bargain package of three *on/off* Dynaquad control rectifiers for \$1.19 per package. Never one to pass up a bargain, we pondered on how to use these solid-state switching transistors in a novel application. Why not a photocell-operated, bi-stable switcher to kill TV commercials?

How It Switches. No doubt you wondered what in the world is the above-mentioned Dynaquad? Basically a Dynaquad is a bi-stable semiconductor that has three or more functions within its four or more semiconductor layers. It can be switched from *off* to *on* or

Flash Switch

from *on* to *off*. Essentially it's similar to a triac, a 4-layer *pnpn* device that, by having the two *pn pn* structures arranged in opposite directions, provides for its bidirectional electrical characteristics. It turns *on* and latches in the *on* state when it's base-biased negatively and can be turned *off* when base-biased positively.

We've employed two photoconductive cells to produce the bias voltages for switching. A sensitive relay in the collector circuit is energized when light from a flashlight illuminates PC1, which develops positive bias to stop conduction, thus de-energizing K1 and connecting the speaker's voice coil. By shining the flashlight beam into PC2, negative bias is developed. Transistor Q1 now conducts, K1 is energized, and the voice coil is disconnected from the output transformer.

Each time the flashlight is flashed into the relevant photocells, the speaker is either disconnected or connected, depending on which photocell is illuminated. Note that we used a relay with spdt contacts that switches the output transformer to a 20-ohm load resistor whenever the speaker voice coil is disconnected. Without this load resistor the amplifier can be permanently damaged whenever the voice coil of the speaker is disconnected, particularly if the audio amplifier is transistorized.

Note also that we connected the relay contacts so that when the relay is not energized the speaker is connected to the output

transformer. This avoids the necessity of having to excite a photocell whenever you do want to listen. Or, if trouble should develop in the switcher, you still will be able to listen to the set without having to operate by-pass switches or go into a major rewiring to remove *FlashSwitch* from the circuit.

Making It. We housed *FlashSwitch* in a black plastic utility box with a removable solid metal cover, in order to reduce to a minimum stray reflections within the box that could spuriously excite the photocells. To further ensure light shielding, we used a black plastic tube to direct light beams to PC2 (the plastic barrel from a standard phone plug will do nicely). Photocell PC1 is about 1/2-in. in diameter and is mounted near the surface of the metal panel. We used a rubber grommet with a hole about 3/8-in. inside diameter to shield PC1.

Most of the parts are mounted on an 8-lug tie strip, except for the power switch S1, relay K1, and the two 9-volt transistor radio batteries B1 and B2, which are mounted directly on the housing as shown in the photos.

In order to separate PC1 and PC2 as far as possible and still keep the size of *FlashSwitch* reasonably small, we placed them at the extremes (right and left) of the tie strip. It's necessary to separate the two cells in order to be able to direct the flashlight beam first to one and then to the other individually so that *on* and *off* switching can be effected. Because this separation is important for successful operation we suggest you follow the layout shown in the photos even though the circuit isn't critical.

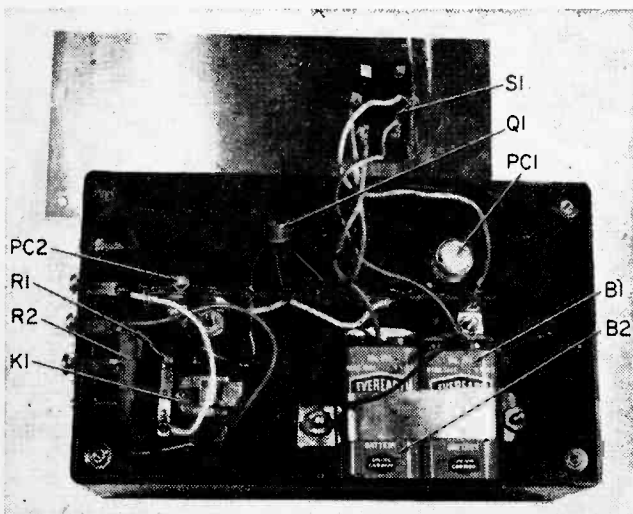

Now you see what's inside our TV-commercial zapper. Only critical positioning to worry about is how and where photocells PC1 and PC2 are located. Keep them as far apart within confines of black-box housing as possible. Screw on plastic handle, if possible. Screw plug shields PC2 from stray light.

SCIENCE FROM ELECTRONICS

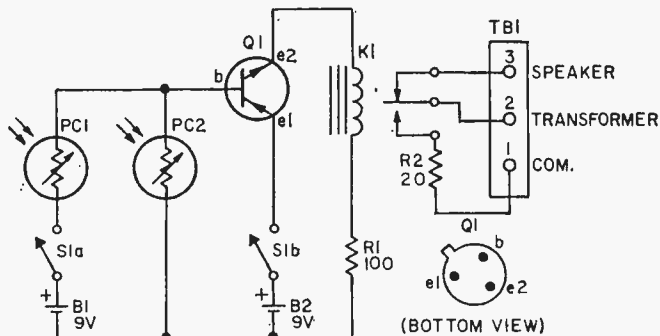

PARTS LIST FOR FLASH SWITCH

- B1, B2—9-V transistor radio battery (Eveready 216 or equiv.)
 K1—DC relay, 7mA at 12 VDC, coil resistance 1000 ohm (Sigma UF-1000-G-S1L or equiv.)
 Q1—Dynaquad switching transistor (Radio Shack 276-553, no equiv. available)
 PC1—Cadmium selenide photocell (Clairex CL504L or equiv.)
 PC2—Cadmium selenide photocell (Clairex CL904 or equiv.)
 R1—100-ohm, ½-watt resistor
 R2—20-ohm, 5-watt resistor

- S1—Dpdt toggle switch (Radio Shack 275-666 or equiv.)
 TB1—3 point screw terminal board (Radio Shack 274-345 or equiv.)
 1—3¾ x 6¼ x 2-in. black plastic molded utility box with removable aluminum cover (Radio Shack 270-627 or equiv.)
 2—Battery Holder, Keystone 203P or equiv. optional—see text)
 Misc.—Bolts, nuts, solder lugs, wire, solder, 8-point tie strip, grommets, plastic sleeving or cap from standard phone plug, etc.

Though we made a simple battery-holding clamp from a ½-in. wide strip of scrap aluminum, you may want to be more professional. Therefore we've listed a commercial battery holder in the Parts List.

Testing It. Since the operation of *FlashSwitch* is dependent on screening out all light except the flashlight rays shined directly at either PC1 or PC2, you will have to test it fully assembled.

Turn *on* S1 and shine a flashlight into PC2. The relay should pull in and hold even after turning *off* the flashlight. If the relay doesn't pull in when the light ray strikes PC2, in all probability the Dynaquad (Q1) is defective. After all, at this price they can't be individually tested before shipment. In fact, it might be a good idea to try out all the ones you bought. You may find one or more better than the one you happened to wire in the first time.

Once you get relay K1 to pull in when PC2 is exposed to the flashlight, shine the ray on PC1. The relay should drop out. If it doesn't, back to the routine of trying another Dynaquad! Now that you have both photocells energizing and de-energizing relay K1, see how far away you can get with the flashlight and still operate the unit. It should work well up to 15 feet away.

Turn *off* or de-energization of K1 is less sensitive than turn *on*. You may have to enlarge the hole in the grommet shielding it to let in more light for maximum sensitivity.

Installing FlashSwitch. In order to hook up *FlashSwitch* to your TV set's necessary is to break one of the leads between the speaker voice coil and the set's output transformer, as shown in the schematic. Make certain that the transformer is connected to *FlashSwitch* terminals 2 and 3. This is necessary to ensure that the load resistor built into *Flash Switch* will always be connected to the transformer whenever the speaker is switched *off*.

Enjoying It. Now that your *FlashSwitch* is completed and hooked up to your TV set, sit back and relax. With your trusty flashlight in hand, you can forevermore enjoy the programs without those annoying commercials dinning in your ears.

If you find *FlashSwitch* is hard to turn *off*, interchange the batteries. After starting off with new batteries having equal voltage it's possible that lower emitter e1 voltage on Q1 will make it harder to turn *off*, if, by chance, B2's voltage drops faster than B1's in normal use. Reversing the battery in position B1 for B2 may restore ease of switching *off*. If not, use a fresh battery for B2. ■



MUSIC on the ROCKS

Thousands of years in formation, the stalactites in a Virginia cavern are now being put to use: as "pipes" for a majestic underground organ. It all began a few years ago, when musician/engineer Leland W. Sprinkle was touring the 64-acre Luray Caverns. During the tour he saw a guide strike one of the cave's stalactites to demonstrate its ability to give off sound. The tuneful vibration which followed and filled the chamber gave Sprinkle the idea which—some years and many thousands of dollars later—has culminated in the world's most unusual organ: the "Stalacpipe." Basically, music is produced by rubber-tipped plungers striking stalactites that have been carefully selected for their pitch and tone. The plungers, electrically powered and electronically controlled, can be actuated in one of two ways: manually, by playing the console; or automatically, by turning an endless belt which is programmed to activate the proper solenoids in proper sequence.

Mechanical and Electrical failure can be predicted by

THE SOUND OF SILENCE

PERHAPS fortunately, nature provided man with only limited hearing—roughly in the region of between 16 cycles and 20,000 cycles per second. Thus man does not hear the rattle of air molecules bumping into each other in a breeze or the rumble of a growing tree. Yet there are such sounds, in fact a complex universe of sounds above and below man's range of hearing. It is a wonder that more human eavesdropping has not taken place in these heretofore supposedly silent regions.

Work now under way in Boeing's aerospace laboratories clearly indicates that tuning in on this cacaphony of silence may be of tremendous benefit to both man and machine. The Boeing work is the brainchild of Harvey Balderston, a research specialist in Boeing's failure analysis laboratory. Balderston reasoned that it might be possible to hear tiny mechanical defects if some way could be found to screen out unwanted noise.

Slowdown. By recording only extremely high frequencies and then slowing them down to the range of human hearing, Balderston *did* screen out unwanted noise. A bearing with only a tiny scratch on its surface sounds like a lively xylophone solo when recorded and played back at a slow speed. A worn hydraulic valve nearing failure sounds like a flushing toilet. Every operating part, according to Balderston, has its own unique, high-frequency beat, hiss, or tinkle which changes as it wiggles and waggles and wears out.

Balderston has listened to the sounds of life itself. He found that an artificial heart valve in a human patient had an acoustic pattern different from a real heart valve. His work with hydraulic fluid flow indicates there is a distinct possibility equipment may some day be developed to listen to the sound of blood flowing through a patient's body, much the way a doctor now listens to a heartbeat with a stethoscope.

A likely early use of failure detectors would be to tune in on automobile problems. Relatively inexpensive equipment could be developed to attach briefly to a transmission, engine, or other automobile power equipment. The mechanic then could listen for indications of trouble. Auto makers already

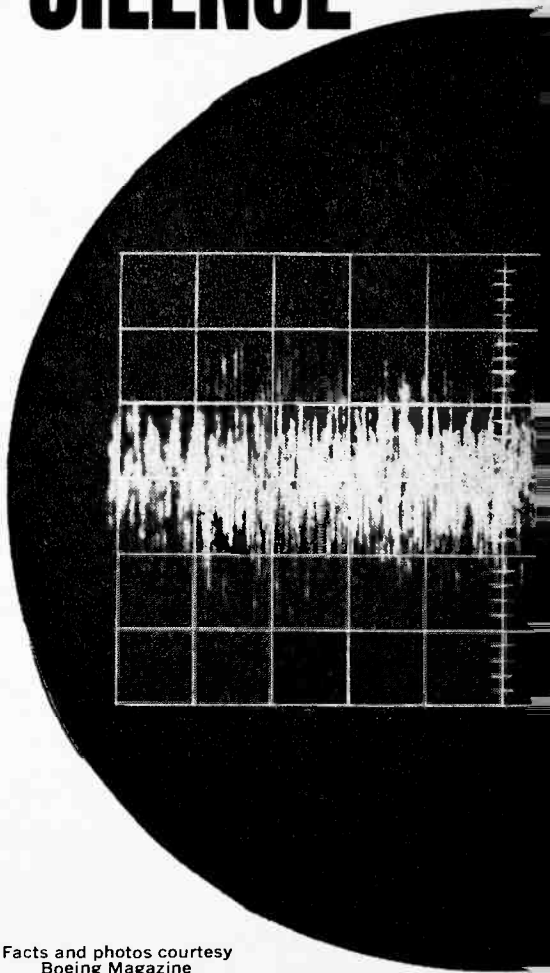

Facts and photos courtesy
Boeing Magazine

SOUND OF SILENCE

have shown interest in developing this kind of diagnostic equipment.

The Sound of Failure. Balderston is currently at the equipment-designing stage of his work, piecing together hardware that could detect the beginning stages of failure in structural, mechanical, hydraulic, or electrical/electronic systems during normal operation. Balderston has discovered several important rules for listening to the silent sounds of failure in the course of his research: 1—all failures are either the result of structural defects or chemical contamination; 2—a defect in one part of a system sets everything in that system to vibrating; and 3—the energy level of the frequencies associated with a failing part is ten thousand to a million or more times higher than normal resonant frequencies. For example, the noise energy level of bubbles from leakage has been found to be an astronomical three billion times higher (over 90 dB) than the level in a good valve.

With this and a few other rules of thumb to go by, Balderston expects to perfect equipment that will quickly and automatically isolate trouble in aircraft and other mechanical systems long before there is any other indication of trouble. A programmed card would be inserted in the test equipment to check bearing surfaces, for example. All bearings could be checked at once, and a meter would indicate the relative amount of wear. More important, red-line emergency condition could be pre-set on the card, and if detected noise exceeded a certain level, a warning light would flash, indi-



Balderston listens in on bearing failure. Wired for sound, bearing sings worried song.



Adding oil to ball bearing just might improve operation; sounds tell for sure.

cating that one of the bearings should be replaced. As visualized by Balderston, the test equipment could be made small enough to be hand-held and, with a change only of the programmed card, one piece of equipment could be used to check any number of systems, whether mechanical, electrical, or structural.

It's the Level! Sounds audible to man would not be required for checking most systems. But when the sounds of failure are brought into the range of human hearing, they provide dramatic evidence of the secrets being discovered. Especially surprising is the noise of crack-resistant metal trying to sew itself into a strong lattice-like structure to stop a crack from spreading. Slowed to human hearing range, this sound is a series of bell-like tinkles, not unlike falling splinters of glass.

"It is the sound of molecules falling into stronger structural units," Balderston explained.

Perhaps the most spectacular proof of the new failure detection system came about quite by accident. Demonstrating his technique to a group of Boeing officials, Balderston set out to show how a deliberately damaged bearing registered a much higher resonant frequency than a new bearing. However, to Balderston's surprise, just the reverse happened. The new bearing had a higher frequency reading than the damaged bearing. Disassembly showed the new bearing had a deep gall across its face, a flaw actually more severe than that inflicted on the test bearing.

Such are the secrets whispered by the sounds of silence. ■

WHITE'S RADIO LOG

An up-to-date Directory of North American AM, FM, and TV Stations, including special sections on World-Wide Shortwave Stations and Emergency Stations for Selected Areas

WHITE'S RADIO LOG CONTENTS FOR 1969-1970

S&E Issue	Listing	Page
Aug./Sept. 1970	U.S. FM Stations by States	82
	Canadian AM Stations by Location	88
	Canadian FM Stations by Location	88
	World-Wide Shortwave Stations	89
	Emergency Radio Services—Pacific Northwest	93
June/July 1970	U.S. AM Stations by Location	80
	World-Wide Shortwave Stations	94
	Emergency Radio Services—Detroit Area	97
April/May 1970	U.S. TV Stations by States	82
	Canadian TV Stations by Cities	84
	Canadian AM Stations by Frequency	86
	World-Wide Shortwave Stations	91
	Emergency Radio Services—Southern California	95
Feb./March 1970	U.S. AM Stations by Frequency	82
	World-Wide Shortwave Stations	96
	Emergency Radio Services—Florida	100
Dec./Jan. 1969-70	U.S. FM Stations by Call Letters	82
	Canadian AM Stations by Call Letters	92
	Canadian FM Stations by Call Letters	92
	World-Wide Shortwave Stations	93
	Emergency R. Services—Washington-Baltimore Area	96
Oct./Nov. 1969	U.S. AM Stations by Call Letters	84
	World-Wide Shortwave Stations	96
	Emergency Radio Services—Philadelphia Area	99

WHITE'S RADIO LOG

U. S. FM Stations by States

Listing indicates stations on the air up to May 1, 1970

Location	Call	MHz	Location	Call	MHz	Location	Call	MHz
ALABAMA								
Abbeville	WARI-FM	94.3	Marysville	KRFD	89.9	Tahoe Valley	KTHO-FM	103.1
Albertville	WRSB	105.1	Mendocino	KMFB-FM	92.7	Thousand Oaks	JNJO	92.7
Alexander City	WRFS-FM	106.7	Merced	KAMB	101.5	Torrance	KNHS	89.7
Andalusia	WNXB	98.1	Modesto	KBEE-FM	103.3	Tracy	KSRT	100.9
Anniston	WHMA-FM	100.5		KTRB-FM	104.1	Truckee	KNLT	101.7
Athens	WJOF	104.3		KDHS	90.5	Tulare	KBOS	94.9
Atmore	WATM-FM	104.1	Mojave	KOOL-FM	97.7		KNNU	106.7
Auburn	WFRI	97.7	Monterey	KWAY	96.9	Twenty-Nine Palms	KQYN	95.7
Bay Minette	WAFI-FM	105.5	Newport Beach	KOCM	103.1		KUKI-FM	93.5
Birmingham	WBRC-FM	106.9	Northridge	KEOC-FM	98.5	Ukiah	KLIL	94.1
	WCRF-FM	96.5	Oceanside	KUDE-FM	102.1		KVFS	95.3
	WOJC	93.7	Oxnard	KSPM-FM	93.5	Vacaville	KBBY	95.1
	WENN-FM	107.7	Ontario	KPMJ	104.7	Ventura	KVEN-FM	100.7
	WVSU-FM	91.1	Pacific Grove	KOCN	104.9	Ventura-Oxnard	KONG-FM	92.1
Carrollton	WWAG	94.1	Palm Springs	KGEC	104.7	Visalia	KDFM	92.1
Clanton	WFZZ	97.7	Pasadena	KPCS	89.3	Walnut Creek	KDFM	92.1
Cullman	WFMH-FM	101.1	Patterson	KPPS-FM	106.7	West Covina	KBOB	98.3
	WKLN	92.1	Redding	KOSO	93.1	Woodland	KRBT	102.5
Deatur	WDRM	102.1	Redlands	KEWB	104.3	COLORADO		
	WRSA	96.9	Ridgecrest	KKOP	93.5	Alamosa	KASF	90.9
Dothan	WOOF-FM	99.7	Riverside	KUOR-FM	96.7	Aspen	KGIW-FM	93.5
	WTYV-FM	95.5	Riverstone	KLOA-FM	105.5	Boulder	KSNP	97.7
Enterprise	WIRB-FM	96.9	Riverside	KACE-FM	92.7	Colorado Springs	KRWN	97.3
Eufala	WULA-FM	92.7		KOUO	97.5		KRCC	91.5
Fairhope	WABF-FM	92.1	Roseville	KUCR	88.1		KKFM	96.5
Florence	WQLT	107.3	Sacramento	KLLU	89.7		KSNS	90.5
Gadsden	WLJM	103.7		KPTP	93.5		KVOR-FM	92.9
Geneva	WGEA-FM	93.5		KQTC	96.1		KPKI-FM	94.3
Guntersville	WWTX	95.9		KERS	90.7		KRDO-FM	95.1
Hamilton	WERH-FM	92.1	Salinas	KFBK-FM	92.5		KRYT-FM	101.9
Homewood	WJLN	104.7		KEBR	100.5	Cortez	KZFM	94.1
Huntsville	WAHR	99.1		KHIQ	105.1	Denver	KODX	105.1
	WNDA	92.9		KJML	106.5		KFML-FM	98.5
Jackson	WHOD-FM	94.9		KSFM	96.9		KLIR-FM	100.3
Mobile	WKRQ-FM	99.9	San Bernardino	KXOA-FM	107.9		KLZ-FM	96.7
	WLPR	96.1		KZAP	98.5		KDOW-FM	96.7
Monroeville	WMFC-FM	98.5		KSBW-FM	102.5		KDEN-FM	99.5
Montgomery	WFMI	98.9		KRSA-FM	100.7		KOA-FM	103.5
	WAJM	193.3		KERR	103.9		KOSI-FM	101.1
	WCOV-FM	97.3		KCR	91.9		KBPI	105.9
	WHYV-FM	101.1		KCR	91.9	Ft. Collins	KCSF-FM	90.9
Musele Shoals	WLAY-FM	105.5		KCRS	95.1		KKFI	99.3
Ooneota	WKLD	97.7	San Diego	KOGO-FM	94.1	Ft. Morgan	KFTM-FM	101.7
Ozark	WOAB	104.9		KBKB	101.5	Grand Junction	KREX-FM	92.3
Roanoke	WELR-FM	95.3		KBBS-FM	89.5	Greeley	KCBL-FM	91.5
Scottsboro	WCNA-FM	98.3		KFBM-FM	100.7		KGRE	92.3
Selma	WTUN	100.1		KFMX	96.5		KWSB-FM	91.9
Sheffield	WRCK-FM	106.3		KITL	105.3	Gunnison	KLMO-FM	104.3
Sylacauga	WMLS-FM	98.3		KDIG	98.1	Lakewood	KLMO-FM	104.3
Tuseumbia	WVNA	100.3		KLRO	94.9	Longmont	KLOV-FM	102.3
Tusealoosa	WUOA	95.7		KPRI	106.5	Loveland	KCMS-FM	102.7
	WACT-FM	105.5		KSDS	88.3	Manitou Springs	KWBI	91.1
ALASKA								
Anchorage	KNIK	105.5		KSBW	102.9	Morrison	KVMN	98.9
	KHAR-FM	103.9		KSDO-FM	103.7	Pueblo	KAVI-FM	95.9
	KWKO	102.1	San Fernando	KSEA	97.3	CONNECTICUT		
College	KYAK-FM	101.3		KVFM	94.3	Bridgeport	WIZZ	99.9
	KUAC	104.7		KSFV	106.3		WPKN	89.5
ARIZONA								
Flagstaff	KAFF-FM	92.9	San Francisco	KALW	91.7	Brookfield	WINE-FM	95.1
Globe	KWBZ-FM	100.3		KCBS-FM	96.9	Danbury	WLAO-FM	98.3
Mesa	KBUZ-FM	104.7		KCDF	102.1	Fairfield	WSHU	91.1
	KMNO-FM	93.3		KEAR	97.3	Groton	WSUB-FM	105.5
Phoenix	KRFM	95.5		KFOG	104.5	Hamden	WHCF-FM	101.3
	KFCB	91.5		KFGS	106.1	Hartford	WHCF-FM	105.9
	KMED-FM	96.9		KGO-FM	100.0		WORC-FM	102.9
	KOOL-FM	94.5		KIDJ	101.3		WCCC-FM	106.9
	KPFL-FM	102.5		KNBR-FM	99.7		WLVH	93.7
	KOY-FM	92.5		KMPX	106.0		WRTC-FM	89.3
	KTAR-FM	98.7		KOIT	93.3		WTIC-FM	96.5
	KYEW	93.3		KQEO-FM	88.5		WUOH	91.3
	KHEP-FM	101.5		KRON-FM	96.5	Hartford-Meriden	WBMI-FM	95.7
	KDOT-FM	109.7		KSAN	94.9	Middletown	WESU	88.1
	KVWM	93.5		KOMA	90.3	New Britain	WRCH-FM	100.5
	KUPD-FM	97.9		KBRG	105.3	New Haven	WNHC-FM	99.1
	KFMW	99.5		KABL-FM	98.1		WYBC-FM	94.3
	KCEE-FM	96.1		KKHI-FM	95.7	New London	WTFD	100.9
	KVOA-FM	93.7		KSJF-FM	92.3	Norwalk	WDRN	95.9
	KWFM	92.9		KKBAY	100.3	Norwich	WICH-FM	97.7
ARKANSAS								
Arkadelphia	KSWH	88.1		KRPM	98.5	Stamford	WSCC-FM	96.7
Baythelille	KLCN-FM	96.1		KSJS	90.7	Storrs	WHUS-FM	91.7
Brinkley	KBRI-FM	102.3		KPLX	106.5	Wallingford	WWEB-FM	90.1
Camden	KWEH	97.3		KATY-FM	96.1	Waterbury	WATR-FM	92.5
Conway	KASC	91.5		KCPR	91.3	Westport	WWCO-FM	104.1
	KVEE-FM	105.1		KSBY-FM	93.3		WWUH	91.3
Crossett	KAGH-FM	104.9		KCSB-FM	91.5	Washington	WASH	97.1
Dardanelle	KCAF-FM	102.3		KOBZ-FM	93.7		WAMH-FM	88.5
El Dorado	KRIL	99.9		KGUD-FM	99.9		WETA-FM	90.9
	KELD-FM	103.1		KMUZ	103.3		WFAN-FM	100.3
Fayetteville	KKEG	92.1		KTMS-FM	97.5		WGAY	99.5
				KSCU	90.1	D. C.		
				KREP	105.7	Washington	WASH	97.1
				KRFM	99.1		WAMH-FM	88.5
				KXFM	99.1		WETA-FM	90.9
				KSM-A-FM	102.5		WFAN-FM	100.3
				KCRW	89.9		WGAY	99.5
				KSRF	103.1			
				KMAX	107.1			
				KUOP	91.3			
				KUQJ	99.3			
				KSTN-FM	107.3			
				KWG-FM	105.7			

RADIO LOG

Location	Call	MHz
Boone	KFGQ-FM	99.3
Burlington	KBUR-FM	107.3
Carroll	KCIM-FM	93.7
Cedar Falls	KTCF	88.1
Cedar Rapids	KHAK-FM	98.4
	KCOE-FM	80.5
	KWNR	99.9
	WMT-FM	96.5
	KRIT	96.9
Clinton	KROS-FM	98.1
Council Bluffs	KRCB-FM	96.5
Creston	WOC-FM	103.7
Davenport	KALA	90.1
	KWNT-FM	106.5
	KDNS-FM	107.1
Denison	KDPS	88.1
Des Moines	KDMI-FM	97.3
	WHO-FM	100.3
	KFMG	94.9
	KRNT-FM	102.5
	KWDM	93.3
Dubuque	WDBQ-FM	105.3
	KEMD	82.9
Estherville	KILB-FM	95.9
Fairfield	KVPC	89.5
Ft. Dodge	KWMT-FM	94.5
Grinnell	KDIC	107.1
Humboldt	KHBT	97.7
Iowa City	KSUI	91.7
	KXIK-FM	100.7
Iowa Falls	KIFG-FM	100.3
LeMars	KLEM-FM	99.5
Maquoketa	KMAQ-FM	95.3
Marshalltown	KFJB-FM	101.1
Mason City	KLSS	106.1
Mt. Vernon	KRNL-FM	89.7
Muscataine	KWRTO	99.7
Newton	KCOB-FM	95.9
Oskaloosa	KBOE-FM	104.9
Pella	KCUJ	89.1
Sioux Center	KDOR	91.3
Sioux City	KDVR	97.9
	KICD-FM	103.3
	KTYT	107.7
Spencer	KAYL-FM	101.5
Storm Lake	KNWS-FM	101.9
Waterloo	KWVL-FM	107.9
	KXEL-FM	105.7
	KNEL-FM	103.9
Waukon	KWAR	86.1
Waverly	KWAW	95.9
Webster City		

KANSAS		
Abilene	KABI-FM	98.3
Baldwin	KNBU	88.9
Dodge City	KGNO-FM	95.5
Emporia	KSTE	88.7
Garden City	KVOE-FM	104.9
Great Bend	KUPK-FM	97.3
Hutchinson	KBJC	91.9
Independence	KSJU	102.1
Junction City	KIND-FM	101.7
Kansas City	KJCK-FM	94.5
	KUDL-FM	98.1
	KCKN-FM	94.1
	KANS-FM	96.7
Larned	KANU	91.5
Lawrence	KLWN-FM	105.9
Leavenworth	KCLO-FM	98.9
Liberal	KJRL	93.3
Manhattan	KSDB-FM	88.1
Newton	KJRF-FM	92.3
Ottawa	KTJO-FM	88.1
	KOFO-FM	95.7
Parsons	KPPS-FM	91.1
Pratt	KWNS-FM	93.1
Russell	KRSL-FM	95.9
Salina	KAFM	99.9
Scott City	KFLA-FM	94.5
Topeka	KTOP	103.3
	KEWI-FM	107.7
	WIBW-FM	97.3
	KFH-FM	97.9
Wichita	KARD	107.3
	KEYN-FM	103.7
	KQTY	101.3
	KMUW	89.1
Winfield	KSWC	88.3

KENTUCKY		
Albany	WANY-FM	106.3
Ashland	WCMI-FM	93.7
Beattyville	WJLG	102.3
Benton	WCBL-FM	96.7
Bowling Green	WLBJ-FM	102.3
Campbellsville	WTGO-FM	103.9
Carrollton	WCYM	100.1
Central City	WNES-FM	101.9

Location	Call	MHz
Columbia	WAIN-FM	93.5
Corbin	WCTT-FM	107.1
	WYGO-FM	102.3
	WQVY-FM	99.3
Cythiana	WNGE	107.1
Danville	WQXE	106.3
Elizabethtown	WHKK	100.9
Erlanger	WWSJ	95.3
Falmouth	WABD-FM	107.9
Ft. Campbell	WSAC-FM	105.5
Ft. Knox	WKYV	104.9
Frankfort	WFUL-FM	104.9
Georgetown	WVRG	90.1
Glasgow	WGGC	95.1
Grayson	WGOH-FM	102.3
Hardinsburg	WHIC-FM	94.3
Harradonburg	WHBN-FM	99.3
Hazard	WKIC-FM	101.1
Henderson	WSON-FM	99.5
	WUAZ	103.1
Hopkinsville	WHOP-FM	98.7
	WKOF	100.3
	WJRS-FM	103.1
Jamestown	WMTM-FM	104.9
Leitchfield	WNBK	91.3
Lexington	WLAP-FM	94.5
	WLEX	98.1
	WVLF-FM	92.9
	WFTG-FM	103.9
London	WPKK	91.9
Louisville	WFPL	89.3
	WHAS-FM	97.5
	WKLO-FM	99.7
	WKRX	106.9
	WLRZ	102.3
Madisonville	WFHM-FM	90.9
Manchester	WWXL-FM	103.3
Mayfield	WNGO-FM	94.7
Maysville	WFTM-FM	95.9
Monticello	WFLW-FM	101.7
Morehead	WMOR-FM	92.1
	WMKY-FM	91.1
Morganfield	WMSJ-FM	95.3
Mt. Sterling	WMST-FM	105.5
Murfordville	WLOC-FM	102.3
Murray	WAWW	103.7
	WKMS-FM	91.3
Owensboro	WOMI-FM	92.5
	WSTO	104.9
Puducuh	WPAD-FM	96.9
	WKYX-FM	93.3
	WSIP-FM	98.9
Paris	WPDE-FM	96.7
Pikeville	WPKE-FM	92.1
Prestonburg	WDOC-FM	95.5
	WPRF	105.1
	WUKP	89.1
Princeton	WPKY-FM	104.9
Richmond	WEKU-FM	88.9
Russellville	WRUS-FM	101.1
St. Mathews	WSTM	103.1
Scottsville	WLCJ	90.7
Somerset	WSEK	96.7
	WSCC	90.7
Stanford	WRSL-FM	95.9
Versailles	WWLV	100.9
Whitesburg	WTCW-FM	103.9

LOUISIANA		
Alexandria	KALB-FM	98.9
	KDBS-FM	100.3
Baton Rouge	WJBO-FM	102.1
	WAFB-FM	98.5
	WQXY-FM	100.7
	WYNK-FM	101.5
DeRidder	KLDA-FM	101.7
Golden Meadow	KLEB-FM	94.3
Hammond	WTGI	103.3
Houma	KCIL	107.1
	KHOM	104.1
Jennings	KJEF-FM	92.7
Jonesboro	KTOC-FM	104.9
Lafayette	KRVS-FM	88.3
	KPEF-FM	99.9
	KSMB	94.5
Lake Charles	KPLC-FM	99.5
	KIKS-FM	96.1
La Place	WKCK	92.3
Marksville	KAPB-FM	97.7
Monroe	KMLB-FM	96.1
	KNOE-FM	101.9
	KREB	106.1
	KMRC-FM	96.7
	KNOC-FM	97.7
	KNIR-FM	99.1
	WBEH	101.9
	WDSU-FM	93.3
	WJMR-FM	97.1
	WNOE-FM	101.1
	WRNO	99.5
	WDOM-FM	98.5
	WWLF-FM	101.9
	WWMT	95.7
Opelousas	KSLO-FM	107.1
Ruston	KRUS-FM	107.1
Shreveport	KRMD-FM	101.1
	KECL-FM	96.5
	KBEL-FM	94.5
	KWKL-FM	96.5
	KWKH-FM	96.5
	WVSL-FM	105.3
Slidell	KTIB-FM	106.3
Thibodaux	KVPI-FM	93.9
Ville Platte		

Location	Call	MHz
W. Monroe	KYEA	98.3
Winfield	KVCL-FM	92.1
Winnsboro	KCRF-FM	95.9

MAINE		
Augusta	WFAU-FM	101.3
Bangor	WABI-FM	97.1
	WMEH-FM	90.9
	WBOR	91.1
	WCME-FM	98.9
	WFST-FM	92.7
	WDEA-FM	95.7
	WCOU-FM	93.9
	WRJR	91.5
	WMEB-FM	91.9
	WLOB-FM	97.9
	WPOR-FM	101.9
	WGNM-FM	102.9
	WRKD-FM	93.5
	WGHM-FM	107.1
	WTVL-FM	98.3

MARYLAND		
Annapolis	WNAV-FM	99.1
	WXTC	107.9
	WEJG	91.5
Baltimore	WCAO-FM	107.9
	WFMM-FM	93.1
	WRBS	95.1
	WBAL-FM	97.9
	WITH-FM	104.3
	WLPL-FM	92.3
	WAGP-FM	108.3
	WTOW-FM	101.9
	WJMD	94.7
	WHFS	102.3
Bethesda	WPGC	95.5
Bradbury Heights	WCEN-FM	106.3
Cambridge	WBUM-FM	95.7
Catonsville	WCUM-FM	102.9
Cumberland	WVWV	106.7
	WKGO	106.1
Frederick	WFRE	99.9
Frostburg	WFRB-FM	105.3
Glen Burnie	WISZ-FM	95.9
Hagerstown	WJLF-FM	104.7
	WARK-FM	108.9
	WHAG-FM	96.7
Havre de Grace	WASA-FM	103.7
Oakland	WBUZ	95.5
	WMSG-FM	92.1
	WBOC-FM	104.7
	WGM-FM	94.3
	WGTS-FM	91.9
	WSDM-FM	104.1
	WTRR-FM	100.7

MASSACHUSETTS		
Amherst	WAMF	89.5
	WFRC	88.3
	WCUA	91.1
	WPA	91.7
	WBUR	90.9
	WBCN	104.1
	WBZ-FM	106.7
	WCOP-FM	100.7
	WEEL-FM	103.3
	WEBS	89.9
	WHDH-FM	94.5
	WJB	96.9
	WROR	98.5
	WBET-FM	97.7
	WBOB	92.7
	WGBH-FM	89.7
	WHRB-FM	95.3
	WTBS	88.1
	WFMP	104.5
	WKOX-FM	105.7
	WVCA-FM	104.9
	WHAI-FM	98.3
	WHAV-FM	92.5
	WCOD-FM	106.1
	WCEN-FM	93.7
	WLLH-FM	99.5
	WLTJ	91.5
	WLYN-FM	101.7
	WYLN-FM	107.9
	WBSM-FM	97.3
	WNBH-FM	98.1
	WNNB-FM	100.1
	WHMP-FM	99.3
	WQRZ	105.5
	WBK-FM	107.7
	WPLM-FM	99.1
	WESO-FM	100.1
	WMHC	88.5
	WHYN-FM	93.1
	WAIC	91.9
	WYVA-FM	102.1
	WCSB	96.7
	WMA5-FM	94.7
	WRLM	93.3
	WBRS	91.7
	WCRB-FM	102.5
	WCOP-FM	94.9
	WCFM	99.1
	WHSR-FM	91.9
	WAFF	107.3
	WICN	90.5
	WSRS	96.1

Location	Call	MHz
Adrian	WLEN	103.9
	WVAC	88.1
Alma	WFCV-FM	104.9
Alpena	WHSB	107.7
	WATZ-FM	93.5
Ann Arbor	WUOM	91.7
	WNRZ	102.9
	WPAG-FM	107.1
Bad Axe	WLEW-FM	92.1
Battle Creek	WCFB-FM	103.3
Bay City	WBCM-FM	96.1
	WGER-FM	102.5
Benton Hbr.	WHFB-FM	99.9
Big Rapids	WBRN-FM	100.9
Birmingham	WHFI	94.7
Cadillac	WTVL-FM	92.9
Charlotte	WCER-FM	92.7
Cheboygan	WCBY-FM	105.1
Clare	WCRM-FM	95.3
Coldwater	WANG-FM	98.5
Dearborn	WKNR-FM	100.3
Detroit	WDET-FM	101.9
	WCHD	105.9
	WBAX	99.5
	WDFE-FM	93.1
	WDTR	90.9
	WGPR	107.5
	WUZZ	103.5
	WMZK	97.9
	WJR-FM	96.3
	WOMC	104.3
	WQRS-FM	105.1
	WWJ-FM	87.1
	WWWW	106.7
	WXYZ-FM	101.1
	WCAR-FM	92.3
	WKAR-FM	90.5
	WFMK	99.1
	WITL-FM	100.7
	WVHS	94.9
	WFBZ	95.1
	WGMZ-FM	107.9
	WMRP-FM	105.5
	WGHM-FM	92.1
	WFRU-FM	102.9
	WJFM	93.7
	WLAJ-FM	96.9
	WYON	101.3
	WOOD-FM	105.7 (s)
	WVGR	104.1
	WXTO-FM	97.9
	WZZM-FM	95.7
	WJIM-FM	102.3
	WILS-FM	87.5
	WTHM-FM	103.1
	WNMR	90.1
	WWMT	95.7
	WALM-FM	104.9
	WDCO-FM	90.7
	WYMO	98.3
	WBRB-FM	102.7
	WCMU	90.1
	WCEN-FM	94.5
	WNUS-FM	106.9
	WNIL-FM	95.3
	WLDM	95.5
	WOAP-FM	103.9
	WJML	98.9
	WMBM-FM	96.7
	WHL5-FM	107.1
	WPAK	89.3
	WOMC	101.3
	WSAM-FM	98.1
	WSBM	106.3
	WWWS	107.1
	WRBJ-FM	92.1
	WSJM-FM	107.1
	WMLC-FM	96.7
	WSHJ	88.3
	WSAE	89.3
	WSTR-FM	99.3
	WDRF-FM	101.9
	WCCW-FM	92.1
	WTCM-FM	103.5
	WTSJ	106.3
	WPHS	91.5
	WEMU	88.1

MINNESOTA		
Alexandria	KXRA-FM	92.7
Austin	KAUS-FM	97.9
Anoka	KTNW	101.9
Ann Arbor	KB5B	91.9
Benson	KBMO-FM	93.5
Blue Earth	KB5W-FM	100.9
Braijnerd	KLIZ-FM	95.7

Location	Call	MHz	Location	Call	MHz	Location	Call	MHz	Location	Call	MHz
Stroudsburg	WVPO-FM	93.5	Fayetteville	WYTM-FM	105.5	KBUY-FM	99.9		KWHO-FM	93.3	
Sunbury	WKOK-FM	94.1	Franklin	WIZO-FM	100.1	KCWM	93.5		KWIC	97.1	
Tamaqua	WSVB	105.5	Gallatin	WFMG	104.5	KFWT-FM	102.1	Spanish Fork	KONI-FM	106.3	
Telford	WBMR	89.7	Greeneville	WOFM	94.9	KNOK-FM	107.5				
Towanda	WTTG-FM	95.3	Henderson	WFHC-FM	91.5	KTCU-FM	89.1				
Tyone	WGRM-FM	102.3	Humboldt	WIRJ-FM	102.3	KWXI	97.1				
Union City	WBFB	106.3	Jackson	WTFJ-FM	104.1	KGAF-FM	94.5	Burlington	WJOY-FM	98.9	
Uniontown	WPOR-FM	91.1	Jamestown	WDEB-FM	100.1	KGBC-FM	106.5		WRUV	90.1	
University Park	WDFM	91.1	Johnson City	WJCV-FM	101.5	KELT	94.5		WVNY	92.9	
Warren	WRRN	92.3	Kingsport	WKPT-FM	98.5	KGRI-FM	100.1	Middlebury	WRMC-FM	91.7	
Washington	WJPA-FM	95.3	Knoxville	WBIR-FM	103.5	KPAN-FM	106.3	Northfield	WNUB-FM	89.1	
Waynesboro	WAYZ-FM	101.5		WEZK	97.5	Highland Park-Dallas	KVIL-FM	103.7	Randolph Center	WVTC	90.7
Wellsboro	WGCR-FM	97.7		WIVK-FM	107.7	Hillsboro	KHBF-FM	102.5	Rutland	WHWB-FM	98.1
Wilkes-Barre	WBRE-FM	98.5		WJCF	91.1	Houston	KHCB-FM	105.7	St. Albans	WBSR-FM	102.3
	WYZZ	92.9		WUOI	91.9		KILT-FM	100.3	White River Junction	WNHV-FM	95.7
	WYZZ	92.9	Lawrenceburg	WDXE-FM	95.9		KFMK	97.9			
Williamsport	WLYG-FM	105.1	Lebanon	WFOF	91.3		KODA-FM	99.1			
	WRAK-FM	102.7		WCOR-FM	173.3		KPFT	90.1			
York	WNOW-FM	105.7	Lenoir City	WLIL-FM	93.5		KLEF	94.5			
York-Hanover	WSBA-FM	103.3	Lewisberg	WJIM-FM	94.3		KLEE	102.9			
	WYCR	98.5	Lexington	WLXJ-FM	99.3		KRBE	104.1			

RHODE ISLAND

Kingston	WRIU	91.1
Providence	WPJB-FM	105.1
	WBRU	95.5
	WDOM	91.3
	WIDE-FM	102.7
	WISF-FM	94.1
	WLKW-FM	101.5
	WPRO-FM	92.3
	WERI-FM	103.7
Woonsocket	WWON-FM	106.3

SOUTH CAROLINA

Aiken	WLOW-FM	95.9
	WAKN-FM	99.3
Anderson	WCAC	101.1
	WANS-FM	107.3
	WWBD-FM	92.7
Bamberg	WBAA-FM	101.7
Barnwell	WBLC-FM	92.1
Batesburg	WBCU-FM	96.3
Beaufort	WCSB-FM	95.1
Charleston	WTMA-FM	96.9
	WCMJ	99.3
Chester	WSBF-FM	99.3
Clemson	WCOS-FM	89.3
Columbia	WNOK-FM	104.7
	WUSC-FM	89.5
Conway	WLAT-FM	104.1
Darlington	WDAR-FM	105.5
Dillon	WDSC-FM	92.9
Due West	WARP	91.7
Enley	WELP-FM	103.9
Florence	WFSN	103.1
Greenville	WESC	95.5
	WFBC-FM	93.7
	WUUU-FM	94.5
Greenwood	WCRS-FM	96.7
Kingstree	WDKD-FM	100.1
Lancaster	WLDM-FM	107.1
Moncks Corner	WVMC	105.5
Myrtle Beach	WMYR-FM	101.7
	WYGR-FM	101.7
N. Charleston	WXTM	102.5
Orangeburg	WDIX-FM	106.7
Reek Hill	WRHI-FM	98.3
Seneca	WBFM	98.3
Spartanburg	WSPR	98.9
Sumter	WFIG-FM	101.3
Waterboro	WALD-FM	100.9

SOUTH DAKOTA

Brookings	KBRK-FM	101.7
	KESD	89.3
Hot Springs	KOBH-FM	96.7
Madison	KIAM-FM	103.1
Rapid City	WVSR	97.9
Sioux Falls	KELO-FM	92.5
	KCHF-FM	93.5
	KNWC-FM	96.5
	KSOF-FM	97.3
Springfield	KSTI	98.5
Vermillion	KUSD-FM	89.9
	KVRF	102.3
Watertown	KDLO-FM	95.3
	KWAT-FM	96.1

TENNESSEE

Bristol	WOP1-FM	96.9
Brownsville	WBHT-FM	95.3
Chattanooga	WDDO-FM	96.5
	WDOY	89.7
	WKES	88.9
	WL0M	100.5
	WDEF-FM	92.3
Cleveland	WDFM	90.9
Clinton	WYSH-FM	104.9
Collegedale	WSMC	90.7
Columbia	WYFY-FM	101.7
Cookeville	WHUB-FM	98.3
	WPTN-FM	94.3
Covington	WKBL-FM	91.3
Crossville	WAEW-FM	92.3
Dickson	WDKN-FM	102.3
Dyersburg	WTR0-FM	100.1
Elizabethton	WLSN	99.3

WYTM-FM	105.5
WIZO-FM	100.1
WFMG	104.5
WOFM	94.9
WFHC-FM	91.5
WIRJ-FM	102.3
WTFJ-FM	104.1
WDEB-FM	100.1
WJCV-FM	101.5
WKPT-FM	98.5
WBIR-FM	103.5
WEZK	97.5
WIVK-FM	107.7
WJCF	91.1
WUOI	91.9
WDXE-FM	95.9
WFOF	91.3
WCOR-FM	173.3
WLIL-FM	93.5
WJIM-FM	94.3
WLXJ-FM	99.3
WLTV-FM	95.9
WMSR-FM	99.3
KMHL-FM	100.1
WCMT-FM	101.7
WKTU	106.9
WHNR	103.9
WHCF-FM	99.7
WJCB	91.1
WHBQ-FM	105.9
WMPS-FM	97.1
WREC-FM	102.7
WTCV	104.5
KWAM-FM	101.1
WKBJ-FM	92.3
WMTL-FM	95.1
WMTS-FM	96.3
WMOT	89.5
WLAC-FM	105.9
WKDA-FM	101.3
WPLN	90.3
WNAX-FM	88.9
WVLT-FM	92.9
WSIX-FM	97.9
WSM-FM	95.5
WATO-FM	94.3
WBNT-FM	105.5
WTPR-FM	105.5
WSEF-FM	95.1
WORM-FM	101.7
WHAL-FM	102.9
WJLE	101.7
WSMT-FM	105.5
WDBL-FM	94.3
WDEH-FM	85.3
WJIG-FM	93.3

TEXAS

Abernathy	KWGO-FM	99.5
Abilene	KACC-FM	91.1
	KFMN	99.3
	KWKC-FM	105.1
	KGNC-FM	93.1
	KDIW-FM	94.1
Amarillo	KHPI-FM	83.1
	KASE	100.7
	KMFA	87.5
	KOKE-FM	95.5
	KTBC-FM	93.7
	KUT-FM	100.7
	KAYD	95.5
	KBPO	74.1
Austin	KTRM-FM	95.1
	KJET-FM	107.7
	KTON	106.3
	KFNE	95.3
Belton	KWHI-FM	106.3
Big Spring	KFPN-FM	99.9
Brenham	KORA-FM	98.3
Brownwood	KLYX	107.1
Bryan	KFAD	94.9
Clear Lake City	WTAW-FM	92.1
Cleburne	KNRO	106.9
College Station	KZFD	95.5
Conroe	KIOU	98.5
Corpus Christi	KSIX-FM	93.9
	KIVY-FM	92.7
	KXIT-FM	95.9
	KIXL-FM	104.5
	KCCD	102.9
	KNUS	98.7
	KRLD-FM	92.5
	WFAA-FM	97.9
	WRR-FM	101.1
	KVTT	91.7
	KXXK	85.3
	KBOF-FM	100.3
	KDLK-FM	94.3
Del Rio	KDSX-FM	101.7
Denison-Sherman	KGCC	87.7
	KDNF-FM	106.1
Denton	KNTU	100.1
	KSPL-FM	95.5
DiBoll	KDDO-FM	95.3
Dumas	KULD-FM	96.9
El Campo	KTEP	88.5
El Paso	KINT-FM	97.5
	KYFF-FM	100.1
	KSET-FM	94.7
	KTSM-FM	99.9
	WBAP-FM	96.3

Gainesville	KGAF-FM	94.5
Galveston	KGBC-FM	106.5
Harlingen	KELT	94.5
Henderson	KGRI-FM	100.1
Hereford	KPAN-FM	106.3
Highland Park-Dallas	KVIL-FM	103.7
Hillsboro	KHBF-FM	102.5
Houston	KHCB-FM	105.7
	KILT-FM	100.3
	KFMK	97.9
	KODA-FM	99.1
	KPFT	90.1
	KLEF	94.5
	KLEE	102.9
	KRBE	104.1
	KXYZ-FM	96.5
	KTRH-FM	101.1
	KUHF	88.7
	KBNO	93.7
Huntsville	KSAM-FM	101.7
Jacksonville	KQOJ	106.5
Jacksonville	KEBE-FM	106.5
Jasper	KTXJ-FM	102.3
Killeen	KLEN-FM	93.3
	KNCT-FM	91.3
	KPUP	97.7
Kingsville	KTAI	91.9
	KLAK	97.9
Lake Jackson	KELE	100.3
Lamesa	KHER	105.7
Lubbock	KSEL-FM	93.7
	KBFM	96.3
	KLBK-FM	94.5
	KTXF-FM	91.9
	KMHT-FM	97.3
	KQXX	98.5
	KAWB	95.3
	KNFM	92.3
	KIMP-FM	100.7
	KMUL-FM	103.1
	KSFM	92.1
	KEFM	103.3
	KNBO	95.9
	KNBT	92.1
	KQIP	96.7
	KOVJ	91.3
	KOYL-FM	97.9
	KOBS-FM	105.5
Orange	KLIS	94.3
Palestine	KPLT-FM	99.3
Paris	KLVL-FM	92.5
Pasadena	KIKK-FM	95.7
	KHBL	88.1
	KPLA	93.7
Plainview	KCAW-FM	93.3
	KPAC-FM	98.5
Port Arthur	KROB-FM	99.9
	KFRD-FM	104.9
	KWLW	93.9
	KKAT	104.7
	KSJT	97.5
	KISS	99.5
San Antonio	KBEB-FM	100.3
	KEEZ	97.3
	KAKI-FM	98.1
	KITV	92.9
	KMFM	96.7
	KCFR-FM	101.9
	KITE-FM	104.5
	KSYM-FM	90.3
	KTFM	107.7
Seguin	KWED-FM	105.3
Sherman	KESH	98.7
Sinton	KTOD-FM	101.3
	KCTA-FM	103.3
	KBMF-FM	98.3
	KQWW	98.3
	KYLE-FM	104.9
	KBFB-FM	106.3
	KTAL-FM	98.1
	KZAK-FM	93.1
	KNUE	101.5
	KTXN-FM	98.7
	KEFC	98.5
Victoria	KWTX-FM	97.5
Waco	KWBU	89.9
	WACO-FM	99.9
	KLUR	99.9
Wichita Falls	KNT0	95.1

UTAH

Cedar City	KCDR-FM	88.1
Centerville	KSTU	105.5
Ephraim	KEPH	88.9
Logan	KUSU-FM	91.5
Ogden	KBOC	101.9
	KWCR-FM	89.1
Parowan	KPNW	90.9
Provo	KBYU-FM	88.9
	KFCM	96.1
Salt Lake City	KCPX-FM	98.7
	KQMU	94.1
	KRSP	103.5
	KSL-FM	100.3
	KSOP-FM	104.3
	KUER	90.1

WHITE'S RADIO LOG

Location	Call	MHz
KBBX	98.9	
KBLE-FM	93.3	
KETV-FM	91.5	
KIRO-FM	100.7	
KISW	99.9	
KLSN	96.5	
KOL-FM	94.1	
KRAB	107.7	
KTW-FM	102.5	
KUOW	94.9	
KIXI-FM	95.7	
KREM-FM	92.9	
KCFA-FM	107.9	
KDNC-FM	93.7	
KTWD	105.7	
KXLY-FM	99.9	
KHQ-FM	98.1	
KPCS	90.9	
KLAY-FM	106.1	
KPLU	88.5	
KTNT-FM	97.7	
KTOY	97.7	
KTAC-FM	103.9	
KPQ-FM	102.1	
KNDX	104.1	
KMWX-FM	107.3	
KIT-FM	94.5	
WEST VIRGINIA		
Beckley	WBKW	99.5
Berkley Springs	WCST-FM	93.5
Bethany	WVBC	88.1
Bluefield	WHS-FM	104.5
Buckhannon	WVVC	88.9
Charleston	WKAZ-FM	97.5
	WCHS-FM	96.1
	WKNA	98.5
	WTIO	102.7
	WVAF	94.9
Charlestown	WZFM	98.3
Huntington	WKEE-FM	100.5
	WMUL	88.1
	WVQM	103.3

Location	Call	MHz
Logan	WVOW-FM	101.9
Martinsburg	WEPN-FM	97.5
Morgantown	WAJR-FM	101.9
Oak Hill	WDAY-FM	94.1
Parkersburg	WTAP-FM	103.1
	WCEF-FM	99.3
St. Albans	WKLC-FM	105.1
Welch	WKCC	97.3
Wheeling	WKWY-FM	97.3
	WVVA-FM	98.7
	WTRF-FM	107.5

WISCONSIN

Location	Call	MHz
Appleton	WLFM	91.1
	WAPL-FM	105.7
Baraboo	WLVE	94.9
Beaver Dam	WBEV-FM	95.3
Beloit	WBGR-FM	88.1
Chilton	WKWK	89.3
Chippewa Falls	WCFW	105.5
Colfax	WHWC	88.3
Delafield	WHAD	90.7
Dodgeville	WDMP-FM	107.1
Eau Claire	WIAL	94.1
	WBM-FM	100.7
	WEAU-FM	104.5
Fond du Lac	WFOG	107.1
Fort Atkinson	WFAW	107.3
Green Bay	WBAY-FM	101.1
	WDOZ-FM	98.3
	WQZ	94.9
Hayward Twp.	WRLS-FM	92.1
Highland	WHHI	91.3
Highland Twp.	WHSA	89.9
Janesville	WJVL	99.9
Kaukauna	WVLE	104.9
Kenosha	WKNZ	95.8
	WLIP-FM	95.1
	WHLA	90.3
	WLLA	93.3
	WHA-FM	88.7
	WIBA-FM	101.5
	WISN-FM	95.7
	WMFM	104.1(s)
	WRVB-FM	102.5
Manitowoc	WKUB	92.1
Marinette	WHMD	91.5
Marshfield	WDLB-FM	106.5
Medford	WGLB	100.1
Menomonie	WZFM	98.3
	WDMW	92.1
	WVSS	89.5
Merrill	WLIN	100.7

Location	Call	MHz
Milwaukee	WXMT-FM	93.5
	WFMR	96.5
	WMIL-FM	95.7
	WISN-FM	97.3
	WRIT-FM	102.9
	WAWA-FM	102.1
	WQFM	91.5
	WTMJ-FM	94.5
	WBJN	107.7
	WNUW	99.1
	WUWM	89.7
	WYMS	88.9
	WEKZ-FM	93.7
	WDDC	99.3
	WCCN-FM	107.5
	WLIH-FM	93.5
	WXIX-FM	107.1
	WCOO-FM	107.1
	WMKC	96.7
	WRST-FM	88.1
	WOSH-FM	103.9
	WNBI-FM	98.3
	WSUP	90.5
	WSWF-FM	99.3
	WPDFR-FM	100.1
	WGLB-FM	100.1
	WPRE-FM	104.3
	WRAC-FM	90.7
	WYNY	92.1
	WRDB-FM	104.9
	WOBT-FM	107.9
	WJMC-FM	96.3
	WRCO-FM	100.9
	WCWC-FM	95.9
	WEVR-FM	103.3
	WRFJ	88.7
	WVLR	96.7
	WTCH-FM	100.1
	WCOW-FM	97.1
	WSPY-FM	97.9
	WSPS	91.9
	WDR-FM	95.9
	WWJC-FM	105.1
	WSSU	91.3
	WRVM	102.7
	WTB-FM	98.9
	WOTC-FM	102.3
	WGBM	102.3
	WTNN-FM	104.7
	WAUK-FM	106.1
	WDX-FM	92.7
	WRIG-FM	101.9
	WHRM	91.9

Location	Call	MHz
Wauwatosa	WIFC	95.5
West Bend	WTOS	103.7
Whitewater	WBKV-FM	92.5
Wis. Rapids	WSUW	91.7
	WRRW	103.3

WYOMING

Location	Call	MHz
Casper	KAWY	94.5
Cheyenne	KVOW-FM	106.3
	KFBC-FM	97.9
	KUWR	91.5

GUAM

Location	Call	MHz
Agana	KUAM-FM	93.9

PUERTO RICO

Location	Call	MHz
Arecibo	WCNM-FM	107.3
	WNKF-FM	106.5
	WABA-FM	100.3
	WRSJ-FM	100.7
	WEYA	84.7
	WJJP-FM	103.3
	WCHQ-FM	102.9
	WYDZ-FM	107.7
	WQAF-FM	107.7
	WORD	92.5
	WMDD-FM	94.7
	WXRE-FM	96.5
	WISA-FM	101.5
	WKBI-FM	99.1
	WOR-FM	97.5
	WDYE-FM	94.1
	WLEO-FM	101.9
	WPAB-FM	93.3
	WPRP-FM	105.1
	WPC	95.1
	WIPR-FM	101.3
	WIAE-FM	92.5
	WTA-FM	104.7
	WKAQ-FM	107.7
	WKYI-FM	105.7
	WFRM	98.5
	WQBS-FM	99.9
	WUPR-FM	104.1
VIRGIN ISLANDS		
Charlotte Amalie	WBNN-FM	97.9
	WESP	101.1
Christiansted	WIVI-FM	99.5

Canadian AM Stations by Location

Location	Call	kHz	Location	Call	kHz	Location	Call	kHz	Location	Call	kHz
Abbotsford, B.C.	CFVR	1240	Drumheller, Alta.	CJDV	910	Huntsville, Ont.	CKAR	630		CJMS	1280
Ajax, Ont.	CHOO	1390	Drummondville, Que.	CHRD	1480	Hull, Que.	CKCH	970		CKAK	730
Alma, Que.	CFGT	1270	Dryden, Ont.	CKDR	900	Inuvik, N.W.T.	CHAK	860		CKLM	1570
Altona, Man.	CFAM	950	Duncan, B.C.	CKAY	1500	Joliette, Que.	CJLM	1350		CKGM	980
Amherst, N.S.	CKDH	900	Edmonton, Alta.	CBX	740	Joniquire, Que.	CKRS	590	Moose Jaw, Sask.	CHAB	800
Amos, Que.	CFSA	1340		CIFD	950	Kamloops, B.C.	CKRS	910	Nanaimo, B.C.	CHAB	800
Antigonish, N.S.	CJFX	1380		CIFD	630	Kapuskasing, Ont.	CKFL	1230	Nelson, B.C.	CKCK	1390
Barrie, Ont.	CKBB	950		CHFA	680		CKAP	580	New Carlisle, Que.	CHNC	610
Bathurst, N.B.	CKBC	1360		CHQT	1110	Kelowna, B.C.	CKOV	630	Newcastle, N.B.	CKMR	790
Bellefleur, Ont.	CJBG	800		CJCA	930	Kenora, Ont.	CJRL	1220	New Glasgow, N.S.	CKEC	1320
Blind River, Ont.	CJNR	730		CKUA	580	Kentville, N.S.	CKEN	1490	New Liskeard, Ont.	CJTT	1230
Brampton, Ont.	CHIC	1330	Edmundston, N.B.	CJEM	570	Kingsville, Ont.	CFCR	1490	New Westminster, B.C.		
Brandon, Man.	CKX	1150	Edson, Alta.	CJVR	970		CKLC	1380	Niagara Falls, Ont.	CJRN	1600
Brantford, Ont.	CKPC	1380	Elliott Lake, Ont.	CKNR	1340	Kirkland Lake, Ont.	CKWS	960	North Battleford, Sask.	CJNB	1050
Bridgewater, N.S.	CKBW	1000	Estevan, Sask.	CJSL	1280	Kitchener, Ont.	CHYM	1490	North Vancouver, B.C.		
Brookville, Ont.	CFJR	1450	Fin Flon, Man.	CFAR	590	Kitimat, B.C.	CKWK	1320	Oakville, Ont.	CKLJ	730
Burns Lake, B.C.	CFLD	1400	Fort Frances, Ont.	CFOB	800	Lac Megantic, Que.	CFKL	1340	Orrville, Ont.	CFOR	1570
Cabano, Que.	CJAF	1240	Fort Nelson, B.C.	CFNL	590	Langley, B.C.	CJJC	850	Oshawa, Ont.	CKLB	1350
Calgary, Alta.	CBR	1010	Fort Simpson, N.W.T.	CFMR	1490	La Parre, Que.	CHGB	1310	Osoyoos, B.C.	CKOD	1240
	CFAC	960	Fort St. John, B.C.	CKNL	560	La Tuque, Que.	CFLM	1240	Ottawa, Ont.	CFOR	1570
	CFCN	1060	Fredericton, N.B.	CBZ	970	Leamington, Ont.	CHYR	710		CFBF	1250
	CFVP	6030	Frobisher Bay, N.W.T.	CFFB	1200	Lethbridge, Alberta	CHEC	1090		CFRA	580
	CHQR	810	Galt, Ont.	CFJT	1110		CJOC	1220		CJRC	1150
	CHQR	1140	Gander, Nfld.	CBG	1450	Levis, Que.	CFLS	1240		CKOY	1310
	CFCH	600	Grand Bay, Nfld.	CBG	1450	Lindsay, Ont.	CFY	910		CKPM	1440
Callander, Ont.	CFWB	1490	Grand Falls, Nfld.	CBT	540	Lloydminster, Alta.	CKSA	1090	Owen Sound, Ont.	CFOS	560
Cambellton, N.B.	CKNB	950	Grand Falls, Nfld.	CKCM	620	London, Ont.	CFPL	580	Parry Sound, Ont.	CKAR-I	1340
Camrose, Alta.	CFWG	790	Grand Forks, B.C.	CKGF	710		CJFE	1270	Peace River, Alta.	CKYL	610
Castlegar, B.C.	CFBR	1230	Gravelbourg, Sask.	CFRG	710		CJVR	1420	Pembroke, Ont.	CHOV	1350
Causapscal, Que.	CJBM	1450	Guelph, Ont.	CJOY	1460		CKSL	1410	Penttieston, B.C.	CKOK	800
Charlottetown, P.E.I.	CFCY	630	Halifax, N.S.	CBH	860		CHCM	560	Peterborough, Ont.	CHEX	980
Chatham, Ont.	CFCO	630		CHNS	950		CKBL	1250		CHFC	560
Chicoutimi, Que.	CBJ	1580		CHN	6130		CHIA	1270		CFBX	1470
	CJMT	1420		CJGH	920		CJVA	1270		CFRY	920
Chilliwack, B.C.	CFMS	1230		CHAM	1280		CKMP	1350		CJAV	1240
Churchill, Manitoba	CHFC	1270		CHML	1500		CBA	1070		CFPA	1230
Collingwood, Ontario	CHUC	1450		CKOC	1150		CFB	640		CFST	580
Collingwood, Ont.	CKCB	1400		CFB	1310		CFB	640		CKPT	580
Corner Brook, Nfld.	CBY	990		CHLC	580		CFB	640		CHQB	1280
	CFCB	570		CHLQ	1150		CFB	640		CKBI	900
	CFSS	1220		CFB	1310		CFB	640		CKPG	550
Cornwall, Ontario	CFSS	1220		CFB	1310		CFB	640		CFPR	860
Courtenay, B.C.	CFCP	1440		CFB	1310		CFB	640		CHB	560
Cranbrook, B.C.	CKEK	570		CFB	1310		CFB	640		CBV	980
Creston, B.C.	CFKC	1340		CFB	1310		CFB	640		CHRC	800
Dartmouth, N.S.	CFDR	790		CFB	1310		CFB	640		CJRP	1060
Dauphin, Man.	CFDH	730		CFB	1310		CFB	640			
Dawson Creek, B.C.	CJDC	1350		CFB	1310		CFB	640			
Debeau, P.Q.	CHVD	1230		CFB	1310		CFB	640			

Location	Call	kHz	Location	Call	kHz	Location	Call	kHz	Location	Call	kHz
Quesnel, B.C.	CKCV	1280	St. Thomas, Ont.	VOWR	800	Sydney, N.S.	CBI	1140	CKWX	1130	
Red Deer, Alta.	CKCQ	570	Saint John, N.B.	CHLO	680		CHER	950	CKZU	6180	
Regina, Sask.	CKRD	850		CBD	1110		CJCB	1270	CKVL	850	
	CBK	540		CFBC	930	Terrace, B.C.	CJGX	6010	CJIB	940	
	CJME	1300		CHSJ	1150	Theftord Mines, Que.	CFRK	590	CFAX	1070	
	CKCK	620	Salmon Arm, B.C.	CKXR	580	Thompson, Man.	CKLD	1230	CJVI	900	
	CKRM	980	Sarnia, Ont.	CHOK	1070	Tillsonburg, Ont.	CHTM	810	CKDA	1220	
Revelstoke, B.C.	CKCR	1340		CKJD	1250	Timmins, Ont.	CKOT	1510	CFDA	1380	
Richmond Hill, Ont.	CFMG	1310	Saskatoon, Sask.	CFNS	1170		CFCL	620	CKVM	710	
Rimouski, Que.	CJBR	900		CFQC	600	Toronto, Ont.	CKGB	680			
Rivière du Loup, Que.	CJFF	1400		CKOM	1250		CBL	740	CKRB	1460	
Roberval, Que.	CHRL	910	Saulte Ste. Marie, Ont.	CJIC	1050		CFRB	1010	CFOM	1340	
Rosetown, Sask.	CKRR	1330		CKCY	920		CFRQ	6070	CJWA	1240	
Rouyn, Que.	CKRN	1400	Schefferville	CBDR	1230		CHFI	880	CHWD	1470	
Ste Agathe			Sept.-Iles, Que.	CKCN	560		CHIN	1540	CFSL	1190	
des Monts, Que.	CJSA	1230	Shawnigan, Sask.	CJSN	1490		CHUM	1050	CFWH	570	
Ste-Anne-			Shawinigan, Que.	CKSM	1220		CJBC	860	CKWL	1240	
des-Monts, Que.	CKGN	1340	Sherbrooke, Que.	CHLT	630		CKEY	590	CFAB	1450	
St. Anthony	CBNA	600		CJRS	1510	Trail, B.C.	CKFH	1430	CBE	1550	
St. Boniface, Man.	CKSB	1050	Simcoe, Ont.	CKTS	900	Trois-Rivières, Que.	CJAT	610	CKLW	800	
St. Catharines, Ont.	CHSC	1220	Smiths Falls, Ont.	CFRS	1560		CHLN	550	CKWW	580	
	CKTB	610	Smithers, B.C.	CJET	630	Truro, N.S.	CJTR	1150	CKNX	920	
St. Eleuthère, Que.	CHRT	1450	Sorel, Que.	CFBV	1230	Valleyfield, Que.	CKCL	600	CBW	990	
St. Hyacinthe, Que.	CKBS	1240	Stratford, Ont.	CJSO	1320	Vancouver, B.C.	CKVD	900	CFRW	1470	
St. Jean, Que.	CHRS	1030	Steinbach, Man.	CJSS	1350		CFLV	1370	CJOB	680	
St. Jérôme, Que.	CKJL	900	Stephenville, Nfld.	CHSM	1250		CBU	690	CKRC	630	
St. John's, Nfld.	CBAN	640	Sudbury, Ont.	CFSX	910		CHQM	1320	CKY	580	
	CJON	930		CFBR	550	Woodstock, N.B.	CJOF	600	CJCY	920	
	CKZN	6160	Summerside, P.E.I.	CHNO	900	Woodstock, Ont.	CKFX	6080	CKOX	1340	
	VOAR	1230	Swift Current, Sask.	CKSO	790	Yarmouth, N.S.	CKLG	730	CJLS	1340	
	VOCM	590		CJRW	1240	Yellowknife, N.W.T.	CKVN	1410	CFYK	1340	
				CKSW	1400	Yorkton, Sask.			CJGX	940	

Canadian FM Stations by Location

Location	Call	kHz	Location	Call	kHz	Location	Call	kHz	Location	Call	kHz
Belleville, Ont.	CJBO-FM	97.1	La Pocatière, Que.	CHGB-FM	102.9	Port Arthur, Ont.	CKPR-FM	94.3	Timmins, Ont.	CKGB-FM	94.5
Brampton, Ont.	CHIC-FM	102.1	Laval, Que.	CFGL-FM	105.7	Quebec, P.Q.	CHRC-FM	98.1	Toronto, Ont.	CBL-FM	94.1
Brandon, Man.	CKX-FM	96.1	Lethbridge, Alberta	CHEC-FM	100.9	Red Deer, Alberta	CKRD-FM	98.9		CHFI-FM	98.1
Brantford, Ont.	CKPC-FM	92.1	London, Ont.	CFPL-FM	95.9	Regina, Sask.	CFMQ-FM	92.1		CHIN-FM	100.7
Calgary, Alta.	CHFM-FM	95.9	Manitowick, Que.	CBFL-FM	98.9	Richibucto, N.B.				CHUM-FM	104.5
Clearwater, B.C.			Merritt, B.C.	CFM-FM-3	103.9	Rimouski, Que.	CBHM-FM	98.5		CJRT-FM	91.1
Clinton, B.C.	CFM-FM-2	92.7	Mount Timothy, B.C.	CFM-FM-5	99.7	Saint John, N.B.	CBJR-FM	98.5	Trail, B.C.	CKFM-FM	95.9
Clinton, B.C.	CFM-FM-4	106.5	Montreal, Que.	CBF-FM	95.1	Saskatoon, Sask.	CFBC-FM	98.9	Truro, N.S.	CKCL-FM	100.9
Cornwall, Ontario	CJSS-FM	104.5		CBM-FM	100.7	Sault Ste. Marie, Ont.	CFMC-FM	103.9	Vancouver, B.C.	CBU-FM	105.7
Edmonton, Alta.	CFRN-FM	100.3		CFQR-FM	92.5		CJUS-FM	89.7		CHUF-FM	97.7
	CJCA-FM	99.5		CJFM-FM	95.9		CJIC-FM	100.5		CHQM-FM	103.5
	CKUA-FM	98.1		CJMS-FM	94.3		CKCY-FM	104.3	Verdun, Que.	CKLG-FM	99.3
Guelph, Ont.	CJOY-FM	106.1		CKGM-FM	97.7	Savona, B.C.	CFW-FM	101.9	Victoria, B.C.	CJMS-FM	95.5
Halifax, N.S.	CHNS-FM	96.1	North Bay, Ont.	CKQM-FM	93.7	Sherbrooke, Que.	CHLT-FM	102.7	Windsor, Ont.	CKLW-FM	93.9
Hamilton, Ont.	CKDS-FM	95.3	Oshawa, Ont.	CKAT-FM	94.9	Smiths Falls, Ont.	CJET-FM	101.1		CKWW-FM	88.7
Kamloops, B.C.	CFM-FM	98.3	Ottawa, Ont.	CKQS-FM	94.9	St. Catharines, Ont.			Winnipeg, Man.	CBW-FM	96.3
Kelowna, B.C.	CJOV-FM	104.7		CKBO-FM	103.3		CHSC-FM	105.7		CFRW-FM	94.3
Kentville, N.S.	CKWM-FM	97.7		CFMO-FM	93.9	Sudbury, Ont.	CKTY-FM	97.7		CJOB	97.5
Kingston, Ont.	CFRC-FM	91.9	Penticton, B.C.	CKOK-FM	97.1	Sydney, N.S.	CKSO-FM	92.7		CKY-FM	92.1
	CKLS-FM	93.3	Peterborough, Ont.			Tillsonburg, Ont.	CJCB-FM	94.9			
	CKWS-FM	96.3		CHEX-FM	101.5		CKOT-FM	100.5			
Kitchener, Ont.	CFCA-FM	105.3									
	CHYM-FM	96.7									

White's World-Wide Shortwave Stations

Prepared by Don Jensen

WE get letters.

"I've tried over and over to hear certain stations, but I can't. What's wrong? Do I need a new receiver?"

And we get letters.

"Your shortwave list is a bummer! I tuned for some of the stations but they aren't there. Shape up, huh!"

Whether inquiry or complaint, the root cause is the same. Some of you simply aren't hearing stations you think you should be hearing.

The complainers—happily, a relative handful—think they know why. It's our fault for giving them a bum steer. To them we'd argue that goofs in White's Worldwide Shortwave Stations list are few. And, when they occur, usually it is because the station has changed schedule or frequency after this column has been "locked up" by the printer.

To those who wonder if new listening

equipment would solve their problems, we'd suggest that it won't help as much as you think. What is really needed, in most cases, is not a scapegoat—man or machine—but, rather, a better understanding of DXing.

The first thing to realize is that SWLing isn't like watching TV, where you check the program guide, switch the channel, and—bingo—there it is. White's SW list, for example, shows Radio Nepal on 11,970 kHz. at 0120 GMT. But it would be unrealistic to expect to hear this station on a regular, daily basis. Maybe you'll hear it the first time you try, but then again it may take ten tries, or a hundred.

Knowledge is the key to successful shortwave listening. Knowledge comes with experience. Learn what you can about radio frequency propagation. Learn what phenomena affect reception, when to expect optimum reception conditions, when log-

WHITE'S SHORTWAVE SECTION

gings over certain global paths are unlikely or technically impossible. Your radio supply store should carry several books for Hams and SWLs that will explain the basics of radio frequency propagation. Pick up a copy and study it. Your own listening will show you when signals from various parts of the world fade in and out on the different shortwave bands.

For many beginning SWLs, language is a problem too. A little study of the major broadcasting languages can go a long way to help. A few key words in each language will allow you to identify many stations that don't air English programs. At the very least, learn the difference in "sound" between languages. Even if you don't understand a word, you can tell Spanish from Portuguese, German from Arabic.

Learn as much as you can about the stations and countries for which you're tuning. A reference notebook, with a page or so for notes on each "wanted" station, may help. Would you expect to hear Spanish programs from a Brazilian station? You'd be surprised how many hobby newcomers do. On which African stations would French programming be likely? Can you tell the difference between Latin American and West African music? Between the music of Mexico and Peru?

Every bit of data you store away may prove useful to you some day in your DX activities. In shortwave listening, savvy is about 80 per cent of the game. Equipment makes up the other 20 per cent.

A widespread misconception among listeners is that a new (and usually more expensive) receiver is all they need to jump their totals from 50 to 150 countries heard in short order. Moving too quickly from an inexpensive receiver to a \$500 Super-G-Whiz can mean disappointment and bitter complaints that the new rig is no better than the old.

Learn to use your present receiving equipment to the best advantage. Even with an inexpensive, kit-built receiver, until you've heard at least 100 different countries, you haven't tapped its full potential. And you will have learned a lot about DXing along the way. There is nothing magical about a more sophisticated radio. It can shave the DX odds in your favor, true, but only if you have the knowhow to take advantage of its superior features. And this takes time.

Don't expect too much, too fast! Take the time to learn as much as you can about the hobby and about your own gear. If you haven't the patience and perseverance, this isn't the place for you. But if you do, you'll find DXing the shortwave bands rewarding, relaxing and fun!

Speaking of Letters. We recently received

Propagation Forecast for August/September 1970

Prepared by C. M. Stanbury II

LISTENER'S STANDARD TIME	ASIA (except Near East)	EUROPE, NEAR EAST & AFRICA (N. of the Sahara)	AFRICA (S. of the Sahara)	SOUTH PACIFIC	LATIN AMERICA
0000-0300	31	31, 41, (49)	31w, 60e	41, (60), (90)	49, 60, (90)
0300-0600	31, 41, (49w)	31 (poor)	19w, 31e	49, 60, 90, (75)	49, 60, (90)
0600-0900	31, (41), (49w)	(16), 19	19, (49w)	25, 31, 60	31, (49)
0900-1200	19, 25	16, 19	19, 25	25	(16), 25, (31)
1200-1500	19, 25	16, 19	19, 25	19	(16), 25, (31)
1500-1800	41	(19), 25, 31, (49)	41w, 60, 90e	19, 25	25, 31
1800-2100	16, 19, (41)	25, 31	25, 31e, 60, 90w	(16), 19	60, 90
2100-2400	19, (31w)	31, 41, 49	60, 90	25, (31w)	60, 90

one from a Michigander who signed it, "Super DXer." In all fairness, lest you condemn him for a certain lack of humility, he appended, parenthetically, "more or less."

So 'much for "Super DXer," but his signature brings to mind some of the other nicknames used by listeners past and present.

One SWL named Paul calls himself "The Big P." Wonder if he's related to another fellow known as "The Jolly Green DXer?" Then there's the "Hoosier Hotshot," and "Mighty Mike," neither of which will win any awards for originality.

A Wisconsin listener has adopted the rank of "Captain" and decorated his DX den in a nautical motif. His listening reports are headed, "From the Captain's log." Well-known medium waver Gordon Nelson of Watertown, Mass., is called "The Admiral," an obvious reference to the hero of Trafalgar, whose surname he bears. And veteran listener Lloyd Hahn, now retired in Florida, is still known as "Rooster" to old timers in the Newark News Radio Club.

Some months ago you may have seen an NBC-TV news interview with William Prater, an official of the United Mine

This Issue's Shortwave Contributors

Everett Slosman (NY); Kim Elliot (Ind.); Carroll Patterson (Ga.); Rick Anderson (Ill.); Frank Peters (Ill.); Marlin Field (Mich.); Christopher Lobdell (Mass.); Dan Ferguson (Fla.); Gregg Calkin (Canada); Bill Sparks (Cal.); Edward Shaw (Cal.); Marvin Robbins (Nebr.); Sam Rowell (Wash.); Don Billingsley (Cal.); Del Hirst (Tex.); Alvin Sizer (Conn.); George Schnabel (NY); A. R. Niblack (Ind.); David Williams (Ore.); Richard E. Wood (Hawaii); Dan Henderson (Md.); Leo Alster (NJ); Gerry Dexter (Wis.); Michael Macken (Mass.); Jim Young (Cal.); Bill Berghammer (NY); Bob Smith (Mich.); John Boessenecker (Cal.); Douglas Smith (Cal.); David Cross (Canada); Newark News Radio Club, 215 Market St., Newark, N.J.; North American SW Association, Box 989, Altoona, Penna.

Workers union. What you probably don't know is that Prater, a Tennessean, once was known in hobby circles as the "Hillbilly DXer," with a log of several thousand stations heard.

But our favorite DX monicker belongs to a New York State listener, Carleton Lord. Many years ago he joined the ranks of nobility by proclaiming himself "Count de Veries." Think about that one!

kH.z.	Call	Name	Location	GMT
2410	4VU	R. Lumiere	Cayes, Haiti	1100
2474	—	—	Hanqchow, China	1300
2510	—	Korean Bc Svc	Seoul, Korea	1300

90-Meter Band—3200 to 3400 kHz

3215	YVOE	Ondas Pan-americanas	El Vigia, Venezuela	0500
3218	—	R. Clube	Lozano Marques,	
		Mozambique		0430
3230	VRH8	R. Fiji	Suva, Fiji	0800
3232	—	RTV Malgache	Tananarive,	
		Malagasy Rep.		0300
3245	VL8BK	R. Kerema	Kerema, Papua Territory	1050
3255	ELBC	Liberian Bc Co	Monrovia, Liberia	2240
3259	—	NHK	Sendai, Japan	0900
3265	ZFY	R. Demerara	Georgetown, Guyana	0950
3275	ZYK28	R. Olinda	Recife, Brazil	0300
3280	—	Windward Is. Bc Svc	St. Georges, Grenada	0100
3305	VL8BD	R. Western District	Daru, Papua Territory	0900
3316	—	R. Sierra Leone	Freetown, Sierra Leone	0700
3320	—	R. Pyongyang	Pyongyang, N. Korea	1400
3350	HIBD	L.V. de la Romana	Sao Domingo, Dominican Rep.	0200
3385	—	R. Cayenne	Cayenne, Fr. Guiana	0030
3385	YVOI	R. Barcelona	Barcelona, Venezuela	0215
3386	CR4AA	R. Clube Cabo Verde	Praia, Cape Verde Is.	2245
3395	YVOK	R. Universidad	Merida, Venezuela	0245
3396	—	RTV Kaduna	Kaduna, Nigeria	0500

60-Meter Band—4750 to 5060 kHz

4650	HCAK2	R. del Ecuador	Guayaquil, Ecuador	0000
4712	HCAV3	R. Luz y Vida	Loja, Ecuador	0600
4735	HCBK2	R. El Mundo	Guayaquil, Ecuador	0300

4753	—	R. Republik Indonesia	Makasar, Indonesia	1230
4767	HJDY	R. Catatumbo	Ocana, Colombia	0300
4770	ELWA	Sudan Interior Mission	Monrovia, Liberia	0700
4770	YVNW	R. Bolivar	C. Bolivar, Venezuela	0100
4777	—	RTV Gabonaise	Libreville, Gabon	0500
4790	HCVP2	R. Atalaya	Guayaquil, Ecuador	0500
4800	—	All India R.	Hyderabad, India	1530
4800	—	ORTF Relay	Brazzaville, Congo Rep.	2200
4807	—	R. Clube	Sao Tome	2115
4807	—	ORTF	St. Denis, Reunion Is.	0230
4815	—	RTV Voltaique	Ouagadougou, Upper Volta	0630
4820	CR6RZ	R. Angola	Luanda, Angola	0530
4820	HRVC	L.V. Evangelica	Teguicigalpa, Honduras	0330
4825	—	—	Askaniabad, USSR	0215
4825	HIFA	L.V. Fuerzas Armadas	Sao Domingo, Dominican Rep.	0100
4828	—	Rhodesian Bc Co	Salisbury, Rhodesia	0400
4834	—	R. Mali	Bamako, Mali	0700
4839	—	R. Bukavu	Bukavu, Congo	0430
4845	—	R. Botswana	Gaborones, Botswana	0400
4850	—	R. Nat.	Nauakchott, Mauritania	2145
4855	—	R. Clube	Lozano Marques, Mozambique	0415
4855	YDK	R. Republik Indonesia	Palembang, Indonesia	1330
4865	—	Emisora Regional Acores	Ponta Delgada, Azores	2230
4865	PRC5	R. Clube Para	Belem, Brazil	0900
4885	—	V. of Kenya	Nairobi, Kenya	0400
4887	ZYG26	R. Pioneira	Teresina, Brazil	0930
4895	OAZ4T	R. Chanchamayo	La Merced, Peru	0700
4912	—	Gilbert/Ellice Bc Svc	Tarawa, Gilbert & Ellice Is.	0730
4915	—	V. of Kenya	Nairobi, Kenya	0330
4920	VLM4	Australian Bc. Corp.	Brisbane, Australia	0830

WHITE'S SHORTWAVE SECTION

kH.z.	Call	Name	Location	GMT
4926	—	R. Equatorial	Bata, Rio Muni	0530
4930	HRVS	R. Catalica	Teguicigalpa, Honduras	1050
4932	—	Nigerian Bc Corp.	Benin City, Nigeria	0600
4940	—	—	Kiev, USSR	0330
4945	ZYE23	R. Educadora	Braganca, Brazil	0935
4950	—	—	—	—
5015	—	Sarawak Windward Is. Bc Svc	Kuching, Sarawak St. Georges, Grenada	1300 2300
5035	—	R. Nat. Centafricaine	Bangui, Central African Rep.	2200
5040	—	Burma Bc Svc	Rangoon, Burma	1200
5085	—	R. Republik Indonesia	Medan, Indonesia	1200

49-Meter Band—5950 to 6200 kHz

5804	—	R. Sanaa	Sanaa, Yemen	0330
5935	YNW	R. Nacional	Managua, Nicaragua	0000
5950	YNRC	R. Zelava	Bluefields, Nicaragua	0135
5955	TGNA	R. Cultural	Guatemala City, Guatemala	0300
5955	—	R. Berlin International	Berlin, E. Germany	0230
5960	CR6RZ	A Voz de Angola	Luanda, Angola	0500
5960	HRRH	L.V. de Occidente	Sta. Rosa Copan, Honduras	1200
5980	YSS	R. Nacional	San Salvador, El Salvador	0000
5985	—	R. Tanzania	Dar es Salaam, Tanzania	0330
5985	LRS2	R. Splendid	Buenos Aires, Argentina	0130
5990	—	R. Sweden	Stockholm, Sweden	0015
5990	HCFA4	L.V. Manabi	Portoviejo, Ecuador	1200
6005	CFCX	Canadian Marconi	Montreal, Canada	2300
6005	—	RIAS	Munich, Germany	0400
6010	CJCX	Gape Breton Bc.	Sydney, Canada	1130
6010	—	RAI	Rome, Italy	0100
6020	OAX4Q	R. Victoria	Lima, Peru	1130
6020	XEUW	Eco de Satovento	Vera Cruz, Mexico	1200
6025	—	R. Portugal	Lisbon, Portugal	0230
6045	HOU3I	L.V. Boru	David, Panama	0300
6050	HRLP	R. America	Teguicigalpa, Honduras	0430
6055	—	R. Rep. Rwandaise	Kigali, Rwanda	0400
6060	—	RAI	Caltanissetta, Sicily	0800
6075	HJCT	R. Sutatenza	Baqaota, Colombia	0100
6075	—	R. South Africa	Johannesburg, South Africa	0430
6080	—	RTV Algerienne	Algiers, Algeria	0700
6082	OAX4Z	R. Nacional	Lima, Peru	0230
6085	—	Bayerischer R.	Munich, Germany	0600
6090	XECMT	R. Mante	C. Mante, Mexico	1230
6090	VLI6	Australian Bc Corp	Sydney, Australia	1230
6095	—	R. Baghdad	Baghdad, Iraq	2000
6097	—	R. Mogadiscio	Mogadiscio, Somalia	0330
6100	—	R. Belgrade	Belgrade, Yugoslavia	2200
6105	XEQM	R. Yucatan	Merida, Mexico	0430
6130	—	R. Ghana	Accra, Ghana	2130
6135	—	R. Warsaw	Warsaw, Poland	1900
6140	—	L.V. Revolution	Bujumbura, Burundi	0430
6141	HCDE4	R. Vision Manta	Manta, Ecuador	0445
6155	—	Far-East Network	Tokyo, Japan	1130
6155	—	Oesterreicher R.	Vienna, Austria	0800
6165	—	R. Zambia	Lusaka, Zambia	0500
6170	—	Philippine Bc Svc	Manila, Philippines	1050
6195	—	R. Bremen	Bremen, Germany	0700
6210	—	R. Nordsee	International Waters	2230
6250	—	R. Sta Isabel	Sta. Isabel, Eq. Guinea	2200

41-Meter Band—7100 to 7300 kHz

7035	—	R. Peking	Peking, China	2330
7050	—	R. Cairo	Cairo, Egypt	0300.

kH.z.	Call	Name	Location	GMT
7045	—	R. Tirana	Tirana, Albania	0630
7115	—	RTV Marocaine	Sebaa-Aioun, Morocco	0830
7120	—	BBC Relay	Tebrau, Malaysia	2200
7145	—	R. Warsaw	Warsaw, Poland	2200
7150	—	Springbok R.	Johannesburg, South Africa	0300
7170	—	R. Noumea	Noumea, New Caledonia	1000
7200	—	Sudan Bc Svc	Omdurman, Sudan	0430
7270	—	R. Republik Indonesia	Diakarta, Indonesia	1130
7275	—	Nigerian Bc Corp	Lagos, Nigeria	0600
7290	—	Trans World R.	Monte Carlo, Monaco	0900
7330	—	—	Kiev, USSR	0100
7345	—	R. Prague	Prague, Czechoslovakia	0130
7480	—	R. Peking	Peking, China	1300

31-Meter Band—9500 to 9775 kHz

9360	—	R. Nacional Espana	Madrid, Spain	0430
9380	—	—	Alma Ata, USSR	0200
9475	—	R. Cairo	Cairo, Egypt	2230
9492	—	R. Tirana	Tirana, Albania	2115
9505	YVXJ	R. Barquisimeto	Barquisimeto, Venezuela	0330
9505	—	Sudan Bc Svc	Omdurman, Sudan	1930
9510	—	R. Bucharest	Bucharest, Rumania	0445
9510	—	R. Kabul	Kabul, Afghanistan	1830
9510	—	BBC Relay	Ascension Is.	2230
9515	TAT	R. Ankara	Ankara, Turkey	2030
9520	VL79	Australian Bc Corp	Port Moresby, Papua Territory	0630
9535	CR6RZ	R. Angola	Luanda, Angola	0500
9545	—	R. Ghana	Accra, Ghana	2200
9550	—	R. Sofia	Sofia, Bulgaria	0445
9560	—	R. Japan	Tokyo, Japan	1600
9570	—	R. Qatar	Doha, Qatar	1730
9575	—	RAI	Rome, Italy	0130
9580	—	V. Philippines	Manila, Philippines	1000
9585	YDF6	V. Indonesia	Diakarta, Indonesia	1330
9595	—	Swiss Bc Corp	Berne, Switzerland	1830
9600	—	R. Tashkent	Tashkent, USSR	1200
9610	LLG	R. Norway	Oslo, Norway	0330
9615	—	RTV Marocaine	Rabat, Morocco	2200
9620	—	R. Belgrade	Belgrade, Yugoslavia	1730
9625	—	Kol Israel	Jerusalem, Israel	2100
9630	—	Vatican R.	Vatican City	1820
9645	TIFC	Faro del Caribe	San Base, Costa Rica	0330
9655	JKH2	R. Japan	Tokyo, Japan	0730
9655	OAX9G	R. Nor Peruana	Chachopoyas, Peru	0345
9670	—	Syrian Bc Svc	Damascus, Syria	2030
9690	—	RAE	Buenos Aires, Argentina	0600
9700	—	R. Sofia	Sofia, Bulgaria	0030
9712	YVKP	R. Tropical	Caracas, Venezuela	0200
9715	—	Cyprus Bc Corp	Nicosia, Cyprus	2030
9725	ETLF	R. V. Gospel	Addis Ababa, Ethiopia	0400
9735	—	Deutsche Weite Relay	Kigali, Rwanda	1515
9745	XYR67	R. Cultura	Sao Paulo, Brazil	0835
9760	—	R. Nacional Espana	Madrid, Spain	0300
9770	4VEH	Evangelistic. V. of West Indies	Cap Haitien, Haiti	1230
9915	—	V. UN Command	Okinawa	1500
9976	—	Yemeni Royalist R.	Unknown	0510

25-Meter Band—11700 to 11975 kHz

11650	—	R. Pakistan	Dacca, E. Pakistan	1720
11705	—	R. Pakistan	Islamabad, W. Pakistan	0130
11705	—	R. Sweden	Stockholm, Sweden	0330

kH _z .	Call	Name	Location	GMT	kH _z .	Call	Name	Location	GMT
11710	—	RAE	Buenos Aires, Argentina	2330	15140	—	Mission Windward Is. Bc Svc	Liberia St. Georges, Grenada	1400 2330
11730	—	R. Nederland	Hilversum, Netherlands	2200	15145	WNYW	R. New York	New York, USA	2200
11735	—	RTV Marocaine	Tangier, Morocco	1800	15160	—	R. Worldwide	Melbourne, Australia	2000
11745	—	R. Cairo	Cairo, Egypt	0115	15165	OZF7	R. Denmark	Copenhagen, Denmark	1500
11754	LRX	R. El Mundo	Buenos Aires, Argentina	0200	15185	—	Far East Bc Assoc.	Victoria, Seychelles	0330
11760	—	R. Havana Cuba	Havana, Cuba	0400	15185	—	ORTF	Paris, France	1930
11780	ZL3	R. New Zealand	Wellington, New Zealand	0700	15235	—	R. Japan	Tokyo, Japan	0100
11795	—	Deutsche Welle	Cologne, Germany	0200	15250	—	R. Bucharest	Bucharest, Rumania	1300
11795	PR139	R. Nacional	Rio de Janeiro, Brazil	0000	15255	—	Vatican R. SODRE	Vatican City, Montevideo, Uruguay	1900 0100
11800	—	R. Nacional Espana Relay	Tenerife, Canary Is.	2330	15285	—	R. Ghana	Accra, Ghana	1900
11820	—	Trans World R.	Bonaire Neth. Antilles	0350	15285	—	V. America Relay	Colombo, Ceylon	1215
11830	—	V. America Relay	Okinawa	2300	15290	—	Syrian Bc Svc	Damascus, Syria	1830
11835	CXA19	R. El Espectador	Montevideo, Uruguay	2330	15315	ETLF	R.V. Gospel	Addis Ababa, Ethiopia	1500
11855	—	Saudi Arabian Bc Svc	Jeddah, Saudi Arabia	1800	15365	—	V. Nigeria	Lagos, Nigeria	1830
11855	ETLF	R. V. Gospel	Addis Ababa, Ethiopia	0250	15400	—	BBC Relay	Ascension Is.	1930
11860	LLJ	R. Norway	Oslo, Norway	2200	15420	—	South East	Manila, Philippines	0100
11866	—	RTV Congolaise	Lubumbashi, Congo	1900	15435	—	Asia R. V. Deutsche Welle Relay	Kigali, Rwanda	2030
11875	—	R. RSA	Johannesburg, South Africa	0300	16-Meter Band—17700 to 17900 kHz				
11875	YNW	R. Nacional	Managua, Nicaragua	1300	17720	BED39	V. Free China	Taipei, Taiwan	0230
11875	—	RAI	Rome, Italy	1800	17755	—	R. Berlin International	Berlin, E. Germany	0200
11880	XERR	R. Comerciales	Mexico City, Mexico	0100	17770	—	RAI	Rome, Italy	1415
11890	DZE9	Far East Bc Corp	Manila, Philippines	0930	17795	—	RAI	Rome, Italy	1500
11900	CE1190	L.V. Chile	Valparaiso, Chile	0030	17840	—	R. Prague	Prague, Czechoslovakia	1600
11920	—	RTV Ivoirienne	Abidjan, Ivory Coast	0700	17875	—	Cyprus Bc Corp	Nicosia, Cyprus	1545
11925	—	R. Tashkent	Tashkent, USSR	1200	17880	—	Oesterreicher R.	Vienna, Austria	1630
11925	—	BBC Relay	Ascension Is.	0500	17885	—	R. Havana Cuba	Havana, Cuba	1800
11949	ZPA5	R. Encarnacion	Encarnacion, Paraguay	0030	17945	—	R. Pakistan	Karachi, Pakistan	1430
11950	—	VTVN	Saigon, Vietnam	1500	13-Meter Band—21450 to 21750 kHz				
11970	—	R. Nepal	Katmandu, Nepal	0120	21480	—	R. RSA	Johannesburg, South Africa	1900
11970	—	R. Lebanon	Beirut, Lebanon	2030	21495	—	R. Portugal	Lisbon, Portugal	1800
19-Meter Band—15100 to 15450 kHz					21520	—	Swiss Bc Corp	Berne, Switzerland	1600
15040	—	R. Euzkadi	Unknown	2030	21585	—	R. Sweden	Stockholm, Sweden	1430
15055	—	R. Cairo	Cairo, Egypt	1600	21740	—	R. Australia	Melbourne, Australia	0200
15060	—	R. Peking	Peking, China	0100	21745	—	R. Kuwait	Kuwait	1630
15080	—	R. Peking	Peking, China	2330					
15115	ELWA	Sudan Interior	Monrovia,						

White's Emergency Radio Station Listings for PACIFIC NORTHWEST

SCIENCE AND ELECTRONICS furnishes this exclusive listing of Pacific Northwest emergency radio stations as an aid to our many readers now engaged in the fascinating and rapidly growing hobby of monitoring emergency radio communications. We have and will be publishing similar lists devoted to different metropolitan areas in forthcoming issues so that you'll be able to accumulate a sizable array of this difficult-to-obtain data. Refer to the index on page 81 for our 1969/1970 program of emergency radio station listings.

If you desire to obtain similar lists from other areas in the United States that have not been published in this magazine, then we suggest you write to Communications Research Bureau, Box 56, Commack, N.Y.

11725. They may have a list of emergency radio services that covers your locality. Include a stamped, self-addressed envelope with your request.

All frequencies are megahertz (MHz) unless otherwise noted. Symbols used are: CD—Civil Defence; FD—Fire Department; LG—Local Government; PD—Police Department; SD—Sheriff or County PD.

IDAHO STATE POLICE

Mobile channels:	42.54	154.71	154.86	154.89	155.07	159.21
Bases:						
Albion	KL1231	42.54				
	KI2523	154.86				
Arco	KOB334	42.54				
Blackfoot	KJZ992	42.54				
Blad Mtn.	KO1389	42.54				
Boise	KOA368	42.54				
	KOB33	155.25				
	KOU73	158.79				
Bonnors Ferry	KOB289	42.54				

WHITE'S EMERGENCY SECTION

Cascade	KJK786	42.54	
	KOI1315	42.54	
Challis	KCN367	42.54	
Chinks Peak	KOB277	42.54	
	KOP42	155.25	
Coeur D'Alene	KOA302	42.54	
	KOR26	154.95	
	KOR27	158.91	
	KOU78	159.21	
	KPO34	158.91	
Delco	KI2525	154.86	
Grangeville	KGP790	42.54	
	KOA323	42.54	
	KOK775	42.54	
Hailey	KOP43	155.07	
Heutter,	KOE389	42.54	
Hollister	KI2522	154.86	
	KOR79	158.79	
Idaho Falls	KFD568	42.54	
	KOS66	159.03	
Inkom	KOB636	42.54	
Jerome City	KOG499	42.54	
	KI2526	154.86	
	KOR25	154.95	
Kamiah	KBJ664	42.54	
Kelllogg	KOI235	42.54	
King Hill	KOH695	42.54	
	KI2524	154.86	
Kooskia	KLD807	42.54	
Lewiston	KOB263	42.54	
	KCK78	154.95	
	KZR52	159.09	
Macks Inn	KBI1817-8	42.54	
McCall	KJK785	42.54	
Mica Mtn.	KOG489	42.54	
Montpelier	KOA300	42.54	
Moscow	KBR221	42.54	
Nezperce	KOM474	42.54	
	KCM52	159.03	
	KZR51	154.65	
Orofino	KOA324	42.54	
Powell	KJU344	159.21	
Preston	KOB251	42.54	
Priest River	KOH644	42.54	
Rexburg	KOB471	42.54	
Rigby	KOA477	42.54	
Riggins	KJF779	42.54	
St. Anthony	KOA515	42.54	
St. Maries	KOB290	42.54	
Salmon	KOY80	155.25	
Sandpoint	KOA987	42.54	
Soda Springs	KOH762	42.54	
Strevell	KOE316	42.54	
Twin Falls	KOU72	158.79	
Wallace	KOG334	42.54	
portable bases	KOG577	42.54	
	KOR70	154.95	155.25
	KOR69	158.79	
	KOY86	154.95	

IDAHO COUNTY AGENCIES

Ada County	SD KGP703	39.82	39.86
	SD KOG991	39.82	39.86
	SD KGP700	47.20	
	SD KH164-5	159.09	
	SD KOW62	159.09	
Bannock County	SD mobiles	39.82	42.54
	LG KGQ92	153.80	
Bingham County	SD KOH242	39.82	39.86
Bonneville County	SD KUA788	39.82	39.86
	SD KBA749	39.82	
	SD KFT625	47.46	
	SD KBV27	459.75	
	LG KHP95-7	72.54	
	LG KCU95	158.88	
Canyon County	SD KOH218	39.82	
Kootenai County	SD mobiles	42.54	
	LG KGU987-90	453.25	458.25
	LG KJB960	453.25	
Latah County	SD KOA525	39.82	
Nezperce County	SD KOA803	39.82	
Shoshone County	SD KDC310	39.82	
	SD KFE50	155.01	
	SD KOS90	156.21	
	SD KFE51	158.73	
	LG KUW92	155.04	
	LG KRY90	155.04	
Twin Falls	SD KOG982	39.82	

OREGON STATE POLICE

Mobile units	42.88	42.94
--------------	-------	-------

Bases:

Albany	KPE73	154.86	
Arlington	KOA381	42.88	42.94
Ashland	KON939	42.88	42.94
Astoria	KOA418	42.88	42.94
Baker	KOA383	42.88	42.94
	KPD21	154.92	
	KPD20	156.03	
Bend	KOB321	42.88	42.94
	KPO92	154.86	
Burns	KOB311	42.88	42.94
Canyon City	KOB309	42.88	42.94
Carpenterville	KAS427	155.91	
Chehalem Mtn.	KON349	42.88	42.94
Clackamas	KAW775	42.88	42.94
Coquille	KOB307	42.88	42.94
	KPA87	159.03	
	KPA88	154.86	
Enterprise	KON823	42.88	42.94
Eugene	KJE228	42.88	42.94
	KOA693	42.88	42.94
	KJW724	42.88	42.94
Florence	KOL482	42.88	42.94
Gilchrist	KEP653	42.88	42.94
Gold Beach			
Government			
Camp	KOB202	42.88	42.94
Groves Pass	KOA513	42.88	42.94
	KOM79	156.03	
	KPG32	154.89	
Hermiston	KCW25	154.92	
Klamath Falls	KOB308	42.88	42.94
LaGrande	KOA744	42.88	42.94
	KAW733	42.88	42.94
	KOS93	156.03	
	KOS94	154.92	
Lakeview	KJE229	42.88	42.94
Marys Peak	KDQ231	42.88	42.94
McMinnville	KOI284	42.88	42.94
Medford	KBG513	42.88	42.94
	KOM78	154.89	
Myrtle Creek	KAT565	42.88	42.94
Newport	KOA315	42.88	42.94
	KZR81	156.03	
	KZR82	154.89	
Odell Lake	KOA296	42.88	42.94
Ontario	KOP39	154.92	
Pendleton	KOA382	42.88	42.94
	KOK62	154.92	
	KOK63	156.03	
Portland	KOA745	42.88	42.94
	KBV43	154.80	
Prineville	KOI354	42.88	42.94
	KON896	42.88	42.94
	KPB44	156.03	
Roseburg	KOB310	42.88	42.94
	KOD47	154.86	
St. Helens	KON822	42.88	42.94
Salem	KDC261	42.88	42.94
	KOA598	42.88	42.94
	KDY26	154.86	
	KPE72	156.03	
The Dalles	KOA293	42.88	42.94
Tilamook	KOB877	42.88	42.94
	KPF28	154.80	
	KPF29	155.91	
Vale	KOA384	42.88	42.94
	KOP38	156.03	
Warm Spgs. Jct.	KOB728	42.88	42.94
Woodburn	KAT566	42.88	42.94
Wyeth	KON938	42.88	42.94
Portable bases	KOA485	42.88	42.94
	KRC86	154.86	
	KNQ31	155.91	
	KNQ32	154.82	

OREGON COUNTY AGENCIES

Clackamas Co.	SD KOL973	155.43	
	SD KOI237	159.03	
	SD KPI79	158.85	
	SD KQP433	460.50	
	LG KOM481	45.44	
Clatsop Co.	SD KJW812	155.55	
	SD KFY939	155.79	
	LG KFY938	154.025	
	LG KZF893	155.715	
Columbia Co.	SD mobiles	155.01	
Coos Co.	SD KOF545	155.25	
Deschutes Co.	SD KON929	453.05	
	SD KON30-1	458.05	
	LG KJW754	45.35	
	LG KZH96	458.35	
Douglas Co.	SD KJE92	155.70	
	SD KOD444	154.95	
	SD KOL484-5	155.70	
	FD KJY804	154.37	
	FD KOI622	154.37	
Jackson Co.	SD KOA885	155.61	

	SD KJY854	155.61		
	SD KOQ50	453.35		
	SD KOQ51	458.35		
Josephine Co.	SD KNE38	154.83		
	SD NE41	154.83		
	SD KJZ20	154.83		
	SD KJY448-9	159.09		
Klamath Co.	LG KON857	45.12		
Lane Co.	SD KFT559	39.82		
	SD KOG326	39.82		
Lincoln Co.	SD KOH435	45.10		
	LG KRZ32	155.055		
	LG KTO51	155.055		
	LG KFN498-9	155.835		
	LG KFX268	155.835		
Linn Co.	SD KCT224	154.71		
	SD KJR438	154.71		
	SD KEN97	453.05		
	SD KEN98	458.05		
Malheur Co.	SD KPL40	155.67		
Marion Co.	SD KOM646	158.91		
	SD KDQ750	154.74		
	SD KI2360	154.74		
	SD KOQ233	154.74		
	SD KH134	155.64		
	LG KDB397	158.94		
	FD KBQ750	153.77	154.16	
	FD KDQ418	153.77	154.16	
Multnomah Co.	SD KEP665	154.83		
	SD KOA282	155.65		
	SD KJY673	158.835		
	SD KOAL353	159.03		
	SD KOA50	72.98	73.18	75.98
	SD KOE65	75.98		
	SD KYT38	75.98		
	SD KITU22	75.98		
	SD KIT80-1	159.09		
	SD KIT87	159.09		
	SD KIT82	159.09		
	SD KPO94-6	158.73	159.09	
	SD KEN91	158.73	159.09	
	SD KGV48	158.73		
	SD KIT80-2	158.73		
	SD KNP65	158.73		
	SD KOA49	158.73	159.09	
	SD KPO97	158.73		
	SD KRQ83	158.73		
	SD KFL83	158.73		
	SD KRO76-7	72.98		
	LG KEM643	153.86		
	LG KDU492	153.86		
	LG KBC435	153.86		
	LG KCI727	153.86		
	LG KDR766	153.86		
	LG KOL926	153.86		
	FD KOK263	154.01	154.175	154.28
Polk Co.	SD KCI55	155.67		
	LG KHP82	158.88		
Umatilla Co.	SD KOQ323	39.82		
	LG KFG64	155.04		
	LG KDC933-4	155.76		
Wasco Co.	SD KAY935	39.82		
	SD KES97	453.40		
	SD KES98	458.40		
Washington Co.	SD KBR983	155.01	159.03	
	SD KLE757	453.40		
	SD KOR568	458.40		
Yamhill Co.	SD KLU309	460.50		
	LG KB1880	45.32		
	LG KOL924	45.32		
	LG KHJ20	72.82		
	LG KHJ21	75.42		
	FD KDC278	154.28		

WASHINGTON STATE POLICE

Mobile units:	154.68	154.77	154.875	155.475	155.52
			155.70	155.85	158.79
Bases:					
Baw Faw	KOA586	154.77	155.475	155.85	
Bellingham	KCL766	155.475	158.79		
	KOA583	154.77	155.475	158.79	
	KDX85	154.68	154.77		
Beverly	KOA584	154.77	155.475	158.79	
Bremerton	KOA589	154.77	154.845	155.475	
Bridgeport	KTC606	158.79			
	KON926	158.79			
Burch Mtn.	KPO66	154.89	155.475		
	KOA587	154.77	154.845	155.475	
		158.79			
Camas	KCL772	155.475	158.79		
Camp Murray	KFT598	158.79			
Chehalis	KOA586	154.77			
	KOE437	158.79			
	KEQ49	154.77	155.475		

Colfax	KCN699	154.77	155.475		
	KOM94	154.77			
Colville	KOG324	154.77	155.475	158.79	
	KDX89	154.68	154.77		
Concrete	KCL767	155.475			
Creston	KDX88	154.77			
Creston Butte	KOA592	154.77	155.475		
Davenport	KCL777	155.475			
Dayton	KCL774	155.475	158.79		
Easton	KCL770	155.475			
Ellensburg	KOA584	154.77	155.475		
	KEQ48	154.77			
Enumclaw	KOA431	154.77	155.475	155.52	
Ephrata	KOE443	154.77	155.475	158.79	
Everett	KOA498	154.77	155.475		
	KEQ50	154.77			
Hoquiam	KOA590	154.77	155.475		
	KDU91	154.77			
Index	KCL768	155.475			
Ione	KCL778	155.475	158.79		
Issaquah	KOA389	154.77	155.475	155.58	
		158.79			
Joe Butte	KOA467	154.77	155.475	158.79	
Kalama	KOA582	154.77	155.475	158.79	
Kelso	KOA582	154.77	155.475		
Kennewick	KOA417	154.77	155.475	155.52	
		158.79			
Monroe	KLI925	155.70			
Morton	KLC771	155.475			
Mt. Vernon	KOE438	158.79			
Naselle Mt	KOA586	154.77	155.475		
Neilton	KCL773	155.475			
North Bend	KOA288	154.77	155.475		
	KDX84	154.77			
Okanogan	KOA439	154.77	155.475		
	KOE51	154.68	154.77		
	KPO68	155.35	158.79		
Olympia	KOA499	154.77	155.475	158.79	
	KOA590	154.77	155.475	158.79	
Pt Angeles	KCL779	155.475	158.79		
	KOA588	154.77	155.475	158.79	
	KDU92	154.68	154.77		
Pt Townsend	KLP864	154.74			
Richland	KJY851	154.77	155.475		
Ritzville	KCL776	155.475			
Seattle	KLL606	154.77	155.475	155.58	
	KOA389	154.77	155.475	155.58	
Shelton	KLI924	155.70			
Spokane	KOA592	42.54	154.77	155.475	
		155.58	158.79		
	KDX87	154.77			
Steptoe	KCL775	155.475			
Sunnyside	KOK918	154.77	155.475		
Tacoma	KOA431	154.77	155.475	155.52	
Vancouver	KOA345	154.77	155.475	158.79	
		462.025			
	KDX83	154.68	154.77		
Walla Walla	KOA467	154.77	155.475	158.79	
	KDX86	154.68	154.77		
Wenatchee	KOA587	154.77	155.475		
	KPO67	155.85			
Yakima	KOA585	154.77	155.475	158.79	
	KQB412	154.77			
Portable base	KCL780	155.475			
	KOH326	154.68	154.77	154.845	
		155.58	155.85		

WASHINGTON COUNTY OPERATED AGENCIES

Benton Co.	SD KOM785	156.15		
	SD KPL81	453.20		
	SD KPL823	458.20		
	LG KBY241	154.10		
	LG KDL95	158.88		
	FD KOM789-91	154.175	154.445	
	FD KSA21	154.415		
	FD KSB37-8	154.415		
	FD WAH66	154.415		
	FD KRQ52	458.75		
	FD KRQ53	453.75		
	FD KTX78	453.60		
	FD KTX79	458.60		
Chelan Co.	SD KJF833	155.37		
	SD KOL234	155.37		
	SD KOH680	155.37		
	LG KOV34	453.45		
	FD KEN48	453.15		
	FD KEN47	458.14		
Clallam Co.	LG KBV949	155.88		
	LG KOM211	155.88		
	LG KPN30-1	158.835		
Clark Co.	SD KCJ23	154.89		
	SD KLI912	155.31		
	SD KOA984	155.31		
	FD KON900	154.37		
	FD KJI442	154.37		
	FD KOK922	154.37		

WHITE'S EMERGENCY SECTION

	FD KCN237	154.37		
	FD KCS987	154.37		
	FD KOL793	154.37		
Cowlitz Co.	SD KGR218	156.21		
	SD KO8404	156.21		
	SD KYA94	155.37		
Franklin Co.	SD KOA527	156.15		
	SD KPO36	453.35		
	SD KPO35	458.35		
	FD KDB384	154.19		
	FD KFB929	154.25		
Grant Co.	SD KOB427	156.15		
	LG KLS505-9	154.085		
	FD KGL472	154.19		
Grays Harbor Co.	KOA398	39.82		
	SD KJW765	39.82		
	SD KJP81	453.40		
	FD KFO757	154.19	154.43	155.085
Island Co.	SD KJV71-4	155.73		
	FD KDX392	154.43		
King Co.	SD KFF218	155.01		
	SD KOA772	155.19		
	SD KDC279	155.19		
	SD KON205	159.09		
	SD KBZ943	155.19	159.09	
	SD KLR452	460.275	460.325	
	SD KML44	465.325		
	LG KBU678	153.755		
	LG KDC281	153.755		
	LG KLY81:3	154.085		
	LG KJV426	453.10		
	LG KZF28-9	458.10		
	FD KOL644	153.95		
	FD KOF989	154.19		
	FD KB822	154.25		
	FD KOK561	154.25		
	FD KOK987	154.25		
	FD KOL375	154.25		
	FD KOM473	154.25		
	FD KOM786	154.25		
Kitsap Co.	LG KGU94	153.92		
	LG KPO66	153.92		
	LG KDN796	158.88		
	LG KJC999	158.88		
	FD KFF228	154.37		
Kittitas Co.	FD KON461	154.37		
	SD KOB272	156.15		
	LG KFW61-2	155.10		
	LG KDT304-6	156.00		
	FD KOI782	154.43		
Lewis Co.	SD KDL844	39.82		

	LG KBW851-2	45.16	155.10	155.47
	FD KON211	154.19		
Okanogan Co.	SD KFO754	155.37		
	SD KPC46	458.35		
	LG KFR36	155.10		
	LG KDB312-4	156.00		
Pierce Co.	SD KOB452	39.82	156.09	
	SD KOG321	156.09		
	CD KDL939	45.20		
	FD KDL938	154.43		
	FD KOB276	154.43		
	FD KOI948	154.43		
	FD KOK692	154.43		
San Juan Co.	SD KCY213	155.61		
Skaqit Co.	SD KOA625	155.31		
	SD KBD77	155.31	155.73	
	FD KDU533	154.43		
	SD KOI647	159.21		
Snohomish Co.	SD KOT76	453.95		
	FD KOF609	154.43		
	FD KOK857	154.43		
	FD KJF939	154.43		
Spokane Co.	SD KF0787	39.82	39.94	
	PD KOW65	159.21		
	FD KOM819	154.43		
Thurston Co.	SD KGL589	39.82		
	SD KOH603	39.82		
	LG KCL204	155.145		
	LG KCW642	155.145		
	LG KLO348	453.975		
	FD KVL91	72.84		
	FD KEP614	154.19		
	FD KOL474	154.19		
	FD KCX427	154.43		
	FD KDA372	154.43		
	FD KFD670	154.43		
	FD KOM707	154.43		
	FD KOL869	154.43		
Walla Walla Co.	SD KOB598	39.82		
	FD KOK870	154.43		
	FD KDJ34	453.50		
	FD KDJ35	458.50		
Whetcom Co.	SD KOI862	155.61		
	FD KOI654	46.14		
	FD KBY736	154.43		
	FD KFD634	154.43		
Whitman Co.	SD KOB279	39.82	39.94	
	SD KDL23	155.13		
	FD KOM472	154.19		
Yakima Co.	SD KON322	156.15		
	SD KOA973	156.15		
	FD KTU74	153.77		
	FD KFD21	153.77		
	FD KOK410-1	154.19		

Voodoo Radio

Continued from page 38

Radio Lumiere. Even more intriguing is the relationship between Haiti's government and 4VU operated by the West Indies Mission at Los Cayes on the republic's South-west peninsula. Though R. Lumiere describes some of its purposes as coping with "the ill winds of discontent sweeping over the world" and persuading Haitians to desert their "voodoo gods," the station once lauded Papa Doc as follows:

"What is the attitude of the government of Haiti? The West Indies Mission enjoys the highest esteem in official circles now as it has in the past for the obvious concrete accomplishments in the lives of the peasant masses . . ."

Noting that it had not sought favors, R. Lumiere continued, "No date has been

set for the expiration of our licenses, and we have been virtually allowed to choose our own frequencies, call letters, and operating hours. We pay no taxes or license fees, for we handle no paid advertisements."

Station 4VU may also hold the distinction of being the sole broadcaster to ever really consider building a station on notorious Navassa Island—a U.S. possession about 40 miles West of Haiti and, as many readers will recall, the fictional home of a widely publicized 1967 hoax station.

R.Lumiere's own hopes of building an FM relay on the island were short lived. One 4VU official took a motor launch out to Navassa and, as he later told an officer of the North American SW Association, he found it infested with snakes and "totally unsuitable" for a radio station.

But to return from the might-have-been to hard reality, R.Lumiere is almost always logged on 2410 kHz, where programs are in French and Creole.

PDQ Reactor

Continued from page 33

tact with the case. Finish up your perfbording process by taking care not to roast the semiconductors and making sure you've wired the relay in properly.

The seeds of your labor are soon to bear fruit. A little more drilling n' filing whips the case's front panel into shape. If you don't feel like hassling through steel case ironmongery, try outboarding the meter, *Calibrate* pots R9 and R10, PB1 and *Time* pot R5 into an aluminum mini-box, interconnecting the cases with a suitable cable.

This arrangement also serves an important purpose if you're considering PDQ's use in a psychology lab or any other controlled-experiment environment. Now the person being tested sees only a neon lamp and a switch. There's no superfluous knobs to twiddle or distracting meter face to subconsciously try to "beat." If you go this route, mount the lamp holder and S1 onto the front of the case.

Let 'er Rip. By now you're chomping at PDQ's bit—but hold back for a moment.

Calibrate the dern thing first! Adjust for meter zero by turning R10 with PB1 depressed. Now depress and quickly release S1; the meter should read near, or over, full scale. Adjust R9 so it reads exactly full scale. Press PB1 again and the meter'll zero. If it doesn't zero the first time, repeat the preceding operation.

Okay, you've waited long enough for the moment of truth. Sit comfortably in front of PDQ. Press S1 and hold it down until I1 extinguishes, then release S1 as quickly as possible. The author tested several people and found that readings averaged from 10 uA. (pretty slow) to 35 uA. with the listed values for R6 and C3.

Setting up the meter movement to read *seconds* requires that you can get your hands on a super-accurate power supply. First, you'll need to refer to a universal capacitor charging curve found in any good engineering text and set up a graph of *Voltage* across C3 versus *Time*. Then connect the accurate voltage supply between circuit common and Q3's gate terminal. Apply a voltage corresponding to several charging time constants (for C3). You'll wind up with a meter face that's calibrated in terms of time. ■

Famous Patents

Continued from page 56

of special purposes, such as in televising motion picture film.

Vladimir Zworykin became a member of the RCA research staff in 1929 and rose to the position of vice-president of RCA in 1947. His researches in various fields of science have led to the granting of more than 120 patents on inventions ranging from radio and television to guided missiles and automobiles.

Perhaps Dr. Zworykin's most important contribution to science and to the human race was his modification and development of the electron microscope into a practical instrument that could be used to study the world of viruses and protein molecules and advance man's knowledge of life itself.

Copies of Vladimir K. Zworykin's Iconoscope patent (which is part of a complete television system) are available for fifty cents each from the U.S. Patent Office, Washington, D.C. 20231. In ordering, give the number of the Patent—No. 2,141,059. ■

Mitchell Uniflash

Continued from page 52

power, wait seven seconds for the capacitors to charge, and then *fire!* You must wait at least seven seconds to allow the capacitors to reach full charge; there is no built-in "ready light."

Checked with a strobemeter, Uniflash produced a guide number of 48 with ASA 50 film. Actually, since much of the illumination on the subject is bounce light because of the bare flashtube, the guide number will vary, depending on the flash-to-subject distance and the color of the room.

Summing Up. While a studio-type, bare-bulb electronic flash is not the universal light source, Uniflash packs a good light output. And it represents an easy answer to the need for bare-bulb, "natural light" lighting techniques.

Uniflash is available in kit (\$79.95) or wired (\$104.95) form. For additional information write Mitchell Enterprises, Dept. S, Box 19562, Dallas, Tex. 75219. Tell 'em you saw it in S/E.

Great Men of Science

Continued from page 38

An intensely practical man, he insisted that men should use heat as a servant. "Put heat to work!" he urged.

He himself invented the drip coffee pot plus the modern fireplace and flue. He invented the steam radiator, installed the world's first central heating systems in buildings used by scientists of France and England.

But the man who founded the science of thermodynamics was more than a scientist-inventor.

Born in Woburn, Mass., he sided with the British in the 1770s. Rumford ranks as one of the earliest professional secret agents, but the full extent of his trickery wasn't disclosed until 150 years after his death. While posing as a patriot he spent at least two years as a British spy.

There was no proof of his duplicity at the time. Still, he thought it wise to go to England in 1776. Before his 22nd birthday he was elevated to the important post of Undersecretary in the Ministry for Carolina and Georgia.

At this early period he made many important experiments concerning the explosive force of gunpowder. He developed

accurate ways to measure the impact of bullets, and founded the deadly science of ballistics.

Not content with high rank and a sheaf of scientific achievements, he tried to sell naval information to the French. Later he transferred his allegiance to Bavaria and rose to the post of prime minister. Made a Count of the Holy Roman Empire in 1791, he took the name Rumford in honor of a village in which he spent several happy years (today, what was Rumford is now Concord, N.H.).

U. S. officials offered him the superintendency of West Point when the military academy was being built—then withdrew the offer in embarrassment when British officials leaked word of his activity during the Revolution.

Undaunted, the scientist who had become a millionaire in an age when few amassed such a fortune, used part of his money to establish one of the world's great scientific bodies—England's famous Royal Institution.

In old age, the man who had fought against Washington and his rebels endowed a professorship at Harvard. No one knows why he did it. To unravel the mysteries of his intrigue-filled life would take decades of research. No other man so deeply involved in international affairs has done so much to make life comfortable for the masses by means of "our servant, heat." ■

IC Low-Bander

Continued from page 63

ground. Connect antenna and ground to clips J1 and J2, respectively, then a 6-volt battery to clips J3 and J4. Be sure polarity is correct and connect either a small PM speaker or headphones to clips J5 and J6.

Oh yes—plug in a coil L1 (A), covering the BCB, for initial checking because there are far more transmissions day and night in that band. Initially turn both volume and regeneration controls fully clockwise. As you tune through from one end of the dial to the other you should hear a chirp or squeal as you tune past each station. If no chirps or squeals are heard reverse connections to the tickler in the tube base.

Set the dial on a strong squeal and rotate regeneration control R1 counterclockwise until you reach a point where the squeal turns into either sweet music or sweet talk.

At this point the volume control should be adjusted to suit your listening pleasure.

Duplicate the above operations for coils L1 (B) and L1 (C). You will gain experience as to where the controls should be set for best performance as you use the receiver. You'll be surprised and delighted at how well it works. ■

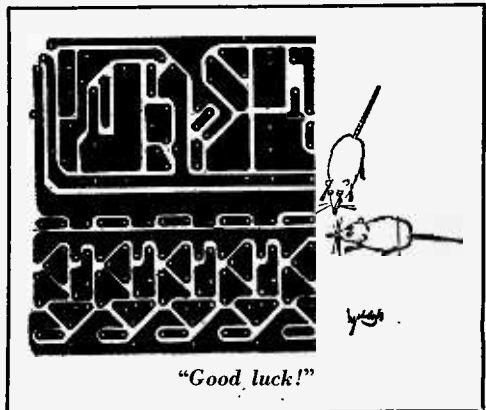

Ham Traffic

Continued from page 65

words, the actual amount of work done by the FCC has no relationship to what it will charge for any particular type of radio license! Not only that, but the number of times a radio user will renew his license in the future also is figured into the bite which the Friendly Candy Company will take out of his billfold.

For example, the various classes of commercial operator's licenses cost \$3, \$4 to \$5. Uncle said he will leave those charges just as they are. However, he will increase from \$2 to \$10 the charge for a restricted radio-telephone operator's permit. This is the type of radio license which pilots and other radio users must have. There is no exam required for this pilot's radio ticket—just fill out a simple form and mail it in—that's all. Some clerk at the FCC types out a little card and mails it back to the pilot—and the ticket is good for life, with no renewal required.

However, for a commercial operator's license, which must be renewed, there is a lengthy technical exam to prepare, administer and grade.

Uncle's "reasoning" for increasing the charge to pilots but not to commercial operators is not based at all on the amount of work done by the FCC in issuing these licenses. Rather the idea is that the pilot's license lasts a lifetime, so they want to get more money from him the first time because they won't get another chance. The commercial operators must renew every five years, so they can hit their pocketbooks repeatedly! *And the FCC admits this in their notice of proposed rule making!*

Type Approval Taxes. Another example of wild Federal bureaucratic thinking is in the case of charges to be made for "type approval" of commercial equipment, such as two-way radio gear and even TV receivers. These charges will be based on the selling price of the equipment and the estimated number of units to be produced! These charges have no relationship to the amount of work performed by the FCC in inspecting this equipment! These charges are taxes, pure and simple—they can't possibly be called "fees." (And remember, only Congress, composed of our elected representatives, is supposed to have the power to tax.)

Charges to broadcast stations would be a certain percentage of their advertising rates for commercial announcements—nothing is said about how much work the FCC would do in regulating these stations—again, you see, another TAX.

Charges to cable TV systems would be based on the number of subscribers they have! Again, no relationship to whatever work the FCC performs for these portions of the industry. And again, another unconstitutional TAX.

How Are Hams Affected? But what does all this mean to ham radio? How does this arrogant attitude affect our future? Very basically, it places our future in complete doubt. If the FCC is allowed to get away with these new charges and the principles they represent, then *the FCC will have the power to put out of business any type of radio communication for which it may acquire a dislike.* Simply by raising the charges so high that no one can afford it.

Look at it this way. Ham license taxes are to go up to \$9, with no logical reasoning behind this increase. Supposedly the general public is now subsidizing ham radio by paying taxes to support the FCC. And why not? The general public benefits in many ways from the activities of ham radio operators, just as it benefits from all forms of radio communications. Yet the FCC wants us to pay \$9 now. If they're allowed to get away with it, what's to prevent them from charging us \$90 next year, or \$900 the following year? The wording in the FCC's new schedule of charges makes this entirely possible.

Incidentally, there was another hooker in the FCC's plan. There was a shorter than normal time allowed for the filing of comments on the proposal, and the FCC said in advance that there would be no extension of time allowed! Now isn't that nice! They spend literally years thinking up this thing, then allow a very short time for everyone involved to digest it, and tell us all in advance that we can't possibly have any additional time for comments, regardless of our reasons for needing it! Real steam roller tactics, by an agency that is supposed to be "serving" us.

They deliberately made it impossible for national publications such as SCIENCE AND ELECTRONICS, and many others, to report the full story to you readers in enough time for you to band together to fight this unfair proposal! ■

Moving Coil Meter

Continued from page 42

Mount the coil assembly in place by stretching the rubber band over pieces G and I, centering it vertically within the height of the pole pieces of the magnet.

Now For The Pointer. Straighten out a $4\frac{3}{4}$ -in. length of #18 gauge bare copper wire and then form it as shown in our drawing. The pointer is cemented in the slot in block J so that it rests near the zero end (left side) of the scale platform with the moving coil at rest with no current flowing. Piece F is used to make final zero rest position adjustments after a scale has been cemented into position.

Fasten two double solder lugs to block H; these are intermediary connecting points for the two wires from the moving coil. Form a helix like a hairspring with each of these leads so they will wind up as the coil assembly moves clockwise. Solder the end of the wire from the top helix to one of the top lugs and the bottom helix to one of the bottom lugs. Mount two Fahnestock clips or binding posts along the front edge of the meter baseboard and connect them to the solder lugs on H, using #18 solid, bare wire. Since meter polarity is determined by magnet polarity and the direction of current flow, depending on how the coil is wound, the correct polarity markings of the meter should be established at the time you calibrate the instrument.

Calibration. In order to calibrate this instrument, you'll need a potentiometer having roughly 200 ohms resistance, a $1\frac{1}{2}$ -volt battery, and a DC milliammeter, preferably a multi-range one available as part of a VOM.

Now you are ready for the calibration scale that's mounted on the platform C made during the framework construction. The scale is drawn on a piece of heavy white paper (U) which will be cemented to the platform after the calibration marks have been drawn. (Rub on numerals, such as Datak, make a neat scale.) Temporarily fasten this white paper (U) to platform C, draw an arc as shown in the photo, and place a mark on the left-hand side for a zero reference point.

Connect a $1\frac{1}{2}$ -volt battery, a 200-ohm potentiometer (used as a rheostat), a VOM set on DC milliamp ranges (or a milliam-

meter), and the moving coil meter you have just built, as shown in the calibration diagram.

Set the potentiometer for maximum resistance and at the start use the highest milliamp range of the VOM. If the pointer on your moving coil meter deflects to the left (below the established 0 point), reverse connections to it and then mark the binding posts + and -. Use the connection diagram to determine their polarity markings after connecting the meter so that the pointer moves to the right.

Slowly turn potentiometer to reduce resistance in the circuit and note the readings of the VOM milliamp range selected. Mark your moving coil meter with the same readings shown on the milliammeter. We divided the 0-100 scale into 10 mA divisions. In commercial manufacture of DC moving coil meters, spring tensions, spacing, and coil weight are carefully controlled so that these meters are linear. For this reason commercial milliammeters have uniform spacing between divisions. Our moving coil meter doesn't have such uniformity because of the variations in the rubber band used for suspension and tension, and because it's difficult to maintain accuracy of positioning the various pieces and to be assured of the strength of magnetic field developed by the magnet. Once you have established the calibration points they will be accurate.

Now that you have marked the scale in pencil you can remove it from the platform and apply the permanent markings. Then permanently fasten the scale in position and stand back to admire your work. If you used reasonable care in following the instructions, you'll have good reason to be proud of your handiwork and should expect a good grade and/or congratulations from your friends and teachers. ■



CLASSIFIED Market Place

FOR BIGGER PROFITS! NEW CAREER OPPORTUNITIES!
READ AND REPLY TO THESE CLASSIFIED ADS

Classified Ads 65¢ per word, each insertion, minimum 10 words, payable in advance. To be included in the next available issue of SCIENCE & ELECTRONICS (formerly RTV-Exp.) copy must be in our New York Office by Aug. 10th. Address orders to C. D. Wilson, Manager, Classified Advertising, SCIENCE & ELECTRONICS, 229 Park Avenue South, New York, N. Y. 10003.

ADDITIONAL INCOME

REPAIR Television Tuners. Free Tricks. F. Bock, Box 833, Redding, Calif. 96001.

FREE Folder Spare Time Incomes. Walker, SMDG, 5302 First Street, Northwest, Washington, D.C. 20011.

MAKE Your Classified Ad Pay. Get "How To Write a Classified Ad That Pays." Includes certificate worth \$2.00 toward classified ad. Send \$1.25 to C. D. Wilson, Science & Mechanics, 229 Park Avenue South, New York, N. Y. 10003.

BOOKS & PERIODICALS

BURIED TREASURE IS EVERYWHERE! New Map Book shows over 400 U.S. Locations. Details Free. Treasure House, 3645 McRee Ave., St. Louis, Mo. 63110.

BUSINESS OPPORTUNITIES

I made \$40,000 Year by Mullorder! Helped others make money! Start with \$10.00—Free Proof! Torrey, Box 318-T, Ypsilanti, Michigan 48197.

FREE Book "900 Successful, Little-Known Businesses." Fascinating! Work home! Plymouth 411-H, Brooklyn, N. Y. 11218.

LOOKING For An Unusual Way To Make Money In The Recent Coin Collecting Boom? Like To Know How To Get Started And Where To Buy And Sell Coins. Than This Booklet Is A Must! \$1.00. Super, 640 Magnus Drive, Coraopolis, Penna. 15108.

ADOPT AN IMPORT Increase the sale potential of your firm. Or start new business or part-time venture. Our newsletter lists hundreds of new foreign products offered by foreign manufacturers to U.S. firms on exclusive basis. Our 20th year. Write for free data. International Intertrade, Box 636-SE, Newark, N.J. 07101.

DO IT YOURSELF

"CRIME BUSTER" First professional Burglar Alarm with Do-It-Yourself Installation Instructions. Free brochure. Silar, 3476-D NW 7th Street, Miami, Fla. 33125.

PRACTICAL tips for home, garden and workshop are in "1001 How-To Ideas." Send \$1.00 for your copy includes Postage. to 1001 How-To Ideas, 229 Park Avenue South, New York, N. Y. 10003.

EDUCATION & INSTRUCTION

EARN College Degrees at home. Many Subjects. FLOYD STATE CHRISTIAN COLLEGE, Post Office Box 1874, Fort Lauderdale, Fla. 33302.

BECOME Ordained Minister. Free Information. Church, Box 191-SE, Auburn, N. Y. 13021.

ELECTRONIC COMPONENTS & KITS

SAVE on Electronic Components. Buy for less than wholesale by learning to unscramble the secret price code used by Pawn Shops. Send \$1.00, I.P.B., P.O. Box 88240-H, Indianapolis, Indiana 46208.

"TREASURE WITCHER" All solid-state transmitter-receiver metal locator—Complete Kit \$45.95 plus \$2.00 shipping. Complete locator checked-out by author \$57.50 plus \$2.00 shipping. Less earphones. See feature article on Locator in 1970 April/May Issue of SCIENCE & ELECTRONICS. List of Kits and plans 25¢. Raikes-Tronics, 2722 Quebec Drive, Little Rock, Ark. 72201.

INVENTIONS WANTED

WE either sell your invention or pay cash bonus. Write for details. Universal Inventions, 298-5, Marion, Ohio 43302.

MISCELLANEOUS

ADULT Books, Magazines! Full Color Catalogue—200 photographs! 25¢ (handling). State Age, Clifton's, Box 1068-7M, Saugus, Calif. 91350.

PSYCHEDELIC Catalog 50 Pages. Send 25¢. Hole In The Wall, 6055-SM, Lankershim, No. Hollywood, Calif. 91606.

MONEYMAKING OPPORTUNITIES

ELECTRONIC moneymaking projects. Experience, investment unnecessary. Manual 25¢. Barla-TWA, Box 15083, San Francisco, Calif. 94115.

HOW Much does being your own boss or making \$25,000.00 per year interest you? The Warner breakthrough in the Engraving field could be your future. Write: Warner, Room CE-105-E, 1512 Jarvis, Chicago, Ill. 60626.

MAKE Big Money raising chinchillas for us. Information 25¢. Keney Brothers, New Freedom, Pa. 17349.

\$350.00 MONTH Addressing! Everything Furnished. Details, mail stamped, addressed envelope and 25¢. Happy, Box 1161-DV, Battle Creek, Mich. 49016.

PERSONAL

ELIMINATE Debts Without Borrowing! Particulars Free. Helper, 10639 Riverside, No. Hollywood, Calif. 91602.

PROFITABLE OCCUPATIONS

LEARN Handwriting analysis—fun, profit. Thompson, 16105-M Delrey, Cleveland, Ohio 44128.

RADIO & TELEVISION

THOUSANDS AND THOUSANDS of types of electronic parts, tubes, transistors, instructions, etc. Send for Free Catalog. Arcturus Electronics Corp., MRT, 502-22nd Street Union City, N. J. 07087.

RADIO & TV Tubes 33¢. Free Catalog. Cornell, 4217 West University, San Diego, California 92105.

RECEIVING & INDUSTRIAL TUBES. TRANSISTORS, All Brands—Biggest Discounts. Technicians, Hobbyists, Experimenters—Request Free Giant Catalog and Save! Zalytron, 469 Jericho Turnpike, Mineola, N. Y. 11501.

"DISTANCE Crystal Set Construction" Handbook—50¢. "Coil Winding"—50¢. Catalog. Laboratories, 2612-II Butano, Sacramento, Calif. 95821.

BLACK and White Television Converted To Color. Patented System. Do It Yourself Kit. Write For Free Brochure. Bele Electronics Corp., 111 N.E. Second Ave., Miami, Fla. 33132.

EXCITING Listening! Police—Fire—Emergency calls on your broadcast radio \$19.95 up! Also crystals—receivers. Scanners, dualband High/Low. Brochures 10¢. Salch Company, Woodsboro 39, Texas 78393.

C. B. BUYERS' Guide—A new magazine for the buyers of Citizen's Band Electronic Equipment. Send \$1.25—includes Postage to C. B. Buyers' Guide, 229 Park Avenue South, New York, New York 10003.

RECORDS, RECORDERS, SOUND EQUIPMENT

FREE Circular. Country Records and Tape Cartridges, Hoedown Fiddle Tunes, Blue Grass, etc. Uncle Jim O'Neal, Box ACA-43, Arcadia, Calif. 91005.

SPECIAL SERVICES

INFORMATION On Anything! Authoritative! \$2.00 (deductible.) Metzler Research P.O. Box 2206MO, Long Island City, N. Y. 11102.

For Greater Classified Profits why not try the new combination classified ad medium

Your classified ad will appear in SCIENCE & MECHANICS MAGAZINE as well as in a minimum of four other SCIENCE & MECHANICS PUBLICATIONS. Write now for information to C. D. Wilson, Manager, Classified Advertising, SCIENCE & MECHANICS, 229 Park Avenue South, New York, N. Y. 10003.

One of our students wrote this ad!

Harry Remmert decided he needed more electronics training to get ahead. He carefully "shopped around" for the best training he could find. His detailed report on why he chose CIE and how it worked out makes a better "ad" than anything we could tell you. Here's his story, as he wrote it to us in his own words.

By Harry Remmert

AFTER SEVEN YEARS in my present position, I was made painfully aware of the fact that I had gotten just about all the on-the-job training available. When I asked my supervisor for an increase in pay, he said, "In what way are you a more valuable employee now than when you received your last raise?" Fortunately, I did receive the raise that time, but I realized that my pay was approaching the maximum for a person with my limited training.

Education was the obvious answer, but I had enrolled in three different night school courses over the years and had not completed any of them. I'd be tired, or want to do something else on class night, and would miss so many classes that I'd fall behind, lose interest, and drop out.

The Advantages of Home Study

Therefore, it was easy to decide that home study was the answer for someone like me, who doesn't want to be tied down. With home study there is no schedule. I am the boss, and I set the pace. There is no cramming for exams because I decide when I am ready, and only then do I take the exam. I never miss a point in the lecture because

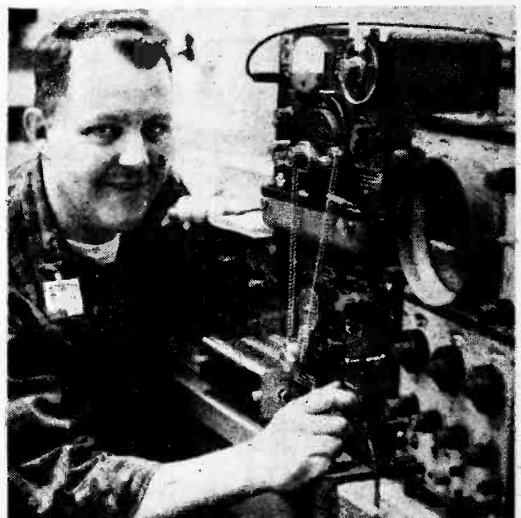

Harry Remmert on the job. An Electronics Technician with a promising future, he tells his own story on these pages.

it is right there in print for as many re-readings as I find necessary. If I feel tired, stay late at work, or just feel lazy, I can skip school for a night or two and never fall behind. The total absence of all pressure helps me to learn more than I'd be able to grasp if I were just cramming it in to meet an exam deadline schedule. For me, these points give home study courses an overwhelming advantage over scheduled classroom instruction.

Having decided on home study, why did I choose CIE? I had catalogs from six different schools offering home study courses. The CIE catalog arrived in less than one week (four days before I received any of the other catalogs). This indicated (correctly) that from CIE I could expect fast service on grades, questions, etc. I eliminated those schools which were slow in sending catalogs

FCC License Warranty Important

The First Class FCC Warranty* was also an attractive point. I had seen "Q" and "A" manuals for the FCC exams,

*CIE backs its FCC License-preparation courses with this famous Warranty: graduates must be able to pass the applicable FCC License exam or their tuition will be refunded in full.

and the material had always seemed just a little beyond my grasp. Score another point for CIE.

Another thing is that CIE offered a complete package: FCC License and technical school diploma. Completion time was reasonably short, and I could attain something definite without dragging it out over an interminable number of years. Here I eliminated those schools which gave college credits instead of graduation diplomas. I work in the R and D department of a large company and it's been my observation that technical school graduates generally hold better positions than men with a few college credits. A college degree is one thing, but I'm 32 years old, and 10 or 15 years of part-time college just isn't for me. No, I wanted to *graduate* in a year or two, not just *start*.

If a school offers both resident and correspondence training, it's my feeling that the correspondence men are sort of on the outside of things. Because I wanted to be a full-fledged student instead of just a tagalong, CIE's exclusively home study program naturally attracted me.

Then, too, it's the men who know their theory who are moving ahead where I work. They can read schematics and understand circuit operation. I want to be a good theory man.

From the foregoing, you can see I did not select CIE in any haphazard fashion. I knew what I was looking for, and only CIE had all the things I wanted.

Two Pay Raises in Less Than a Year

Only eleven months after I enrolled with CIE, I passed the FCC exams for First Class Radiotelephone License with Radar Endorsement. I had a pay increase even before I got my license and *another* only ten months later. I'm getting to be known as a theory man around work, instead of one of the screwdriver mechanics.

These are the tangible results. But just as important are the things I've learned. I am smarter now than I had ever thought I would be. It feels good to know that I know what I know now. Schematics that used to confuse me completely are now easy for me to read and interpret. Yes, it is nice to be smarter, and that's probably the most satisfying result of my CIE experience.

Praise for Student Service

In closing, I'd like to get in a compliment for Mr. Chet Martin, who has faithfully seen to it that my supervisor knows I'm studying. I think Mr. Martin's monthly reports to my supervisor and generally flattering commentary have been in large part responsible for my pay increases. Mr. Martin has given me much more student service than "the contract calls for," and I certainly owe him a sincere debt of gratitude.

And finally, there is Mr. Tom Duffy, my instructor. I don't believe I've ever had the individual attention in any classroom that I've received from Mr. Duffy. He is clear, authoritative, and spared no time or effort to answer my every question. In Mr. Duffy, I've received everything I could have expected from a full-time private tutor.

I'm very, very satisfied with the whole CIE experience.

ENROLL UNDER NEW G.I. BILL

All CIE courses are available under the new G.I. Bill. If you served on active duty since January 31, 1955, or are in service now, check box on reply card or coupon for G.I. Bill information.

Every penny I spent for my course was returned many times over, both in increased wages and in personal satisfaction.

Perhaps you too, like Harry Remmert, have realized that to get ahead in Electronics today, you need to know much more than the "screwdriver mechanics." They're limited to "thinking with their hands"...learning by taking things apart and putting them back together...soldering connections, testing circuits, and replacing components. Understandably, their pay is limited—and their future, too.

But for men like Harry Remmert, who have gotten the training they need in the fundamentals of Electronics, there are no such limitations. As "theory men," they think with their heads, not their hands. For trained technicians like this, the future is bright. Thousands of men are urgently needed in virtually every field of Electronics, from two-way mobile radio to computer testing and troubleshooting. And with this demand, salaries have skyrocketed. Many technicians earn \$8,000, \$10,000, \$12,000 or more a year.

Send for Complete Information—FREE

Many men who are advancing their Electronics career started by reading our famous book, "How To Succeed In Electronics." It tells of the many electronics careers open to men with the proper training. And it tells which courses of study best prepare you for the work you want.

If you're "shopping around" for the training you need to move up in Electronics, this 44-page book may have the answers you want. We'll send it to you FREE. With it, we'll also include our other helpful book, "How To Get A Commercial FCC License."

To get both FREE books, just fill out and mail the bound-in postpaid card. If the card is missing, send the coupon below.

CIE Cleveland Institute of Electronics

1776 East 17th Street, Cleveland, Ohio 44114

Accredited Member National Home Study Council • A Leader in Electronics Training Since 1934

NEW COLLEGE-LEVEL COURSE IN ELECTRONICS ENGINEERING

for men with prior experience in Electronics. Covers steady-state and transient network theory, solid state physics and circuitry pulse techniques, computer logic and mathematics through calculus. A college-level course for men already working in Electronics.

Cleveland Institute of Electronics
1776 East 17th Street, Cleveland, Ohio 44114

Please send me without cost or obligation:

1. Your 44-page book "How To Succeed In Electronics" describing the job opportunities in Electronics today, and how your courses can prepare me for them.
2. Your book on "How To Get A Commercial FCC License."

I am especially interested in:

- | | |
|--|--|
| <input type="checkbox"/> Electronics Technology | <input type="checkbox"/> Electronic Communications |
| <input type="checkbox"/> Broadcast Engineering | <input type="checkbox"/> Industrial Electronics and Automation |
| <input type="checkbox"/> First-Class FCC License | <input type="checkbox"/> Electronics Engineering |

Name _____ (PLEASE PRINT)

Address _____

City _____

State _____ Zip _____ Age _____

Check here for G.I. Bill information. EX-41

FULL 20 RADIO

and Electronics Circuits

PROGRESSIVE HOME RADIO-T.V. COURSE

Now Includes

- ★ 12 RECEIVERS
- ★ 3 TRANSMITTERS
- ★ SQ. WAVE GENERATOR
- ★ SIGNAL TRACER
- ★ AMPLIFIER
- ★ SIGNAL INJECTOR
- ★ CODE OSCILLATOR

- ★ No Knowledge of Radio Necessary
- ★ No Additional Parts or Tools Needed
- ★ EXCELLENT BACKGROUND FOR TV
- ★ SCHOOL INQUIRIES INVITED
- ★ Sold In 79 Countries

YOU DON'T HAVE TO SPEND HUNDREDS OF DOLLARS FOR A RADIO COURSE

The "Edu-Kit" offers you an outstanding PRACTICAL HOME RADIO COURSE at a rock-bottom price. Our Kit is designed to train Radio & Electronics Technicians, making use of the most modern methods of home training. You will learn radio theory, construction practice and servicing. THIS IS A COMPLETE RADIO COURSE IN EVERY DETAIL. You will learn how to build radios, using regular schematics; how to wire and solder in a professional manner; how to service radios. You will work with the standard type of punched metal chassis as well as the latest development of Printed Circuit chassis.

You will learn the basic principles of radio. You will construct, test and work with RF and AF amplifiers and oscillators, detectors, rectifiers, test equipment. You will learn trouble-shooting, using the Progressive Signal Tracer, Progressive Signal Injector, Progressive Dynamic Radio & Electronics Tester, Square Wave Generator and the accompanying instructional material.

You will receive training for the Novice, Technician and General Classes of F.C.C. Radio Amateur Licenses. You will build Receiver, Transmitter, Square Wave Generator, Code Oscillator, Signal Tracer and Signal Injector Circuits and learn how to operate them. You will receive an excellent background for television, Hi-Fi and Electronics. This is absolutely no previous knowledge of radio or science is required. The "Edu-Kit" is the product of many years of teaching and engineering experience. The "Edu-Kit" will provide you with a basic education in Electronics and Radio, worth many times the low price you pay. The Signal Tracer alone is worth more than the price of the kit.

THE KIT FOR EVERYONE

You do not need the slightest background in radio or science. Whether you are interested in Radio & Electronics because you want an interesting hobby, a well paying business or a job with a future, you will find the "Edu-Kit" a worth-while investment. Many thousands of individuals of all

ages and backgrounds have successfully used the "Edu-Kit" in more than 79 countries of the world. The "Edu-Kit" has been carefully designed, step by step, so that you cannot make a mistake. The "Edu-Kit" allows you to teach yourself at your own rate. No instructor is necessary.

PROGRESSIVE TEACHING METHOD

The Progressive Radio "Edu-Kit" is the foremost educational radio kit in the world, and is universally accepted as the standard in the field of electronics training. The "Edu-Kit" uses the modern educational principle of "Learn by Doing." Therefore you construct, learn schematics, study theory, practice trouble shooting—all in a closely integrated program designed to provide an easily-learned, thorough and interesting background in radio.

You begin by examining the various radio parts of the "Edu-Kit." You then learn the function, theory and wiring of these parts. Then you build a simple radio. With this first set you will enjoy listening to regular broadcast stations, learn theory, practice testing and trouble-shooting. Then you build a more advanced radio, learn more advanced theory and techniques. Gradually in a progressive manner and at your own rate you will find yourself constructing more advanced multi-tube radio circuits, and doing work like a Professional Radio Technician.

Included in the "Edu-Kit" course are Receiver, Transmitter, Code Oscillator, Signal Tracer, Square Wave Generator and Signal Injector Circuits. These are not unprofessional "breadboard" experiments, but genuine radio circuits, constructed by means of professional wiring and soldering on metal chassis, plus the new method of radio construction known as "Printed Circuitry." These circuits operate on your regular AC or DC house current.

THE "EDU-KIT" IS COMPLETE

You will receive all parts and instructions necessary to build twenty different radio and electronics circuits, each guaranteed to operate. Our Kits contain tubes, tube sockets, variable, electrolytic, mica, ceramic and paper dielectric condensers, resistors, tie strips, hardware, tubing, punched metal chassis, Instruction Manuals, hook-up wire, solder, selenium rectifiers, coils, volume controls and switches, etc.

In addition, you receive Printed Circuit materials, including Printed Circuit chassis, special tube sockets, hardware and instructions. You also receive a useful set of tools, a professional electric soldering iron, and a self-powered Dynamic Radio and Electronics Tester. The "Edu-Kit" includes Code Instructions and the Progressive Code Oscillator, in addition to F.C.C. Radio Amateur License training. You will also receive lessons for servicing with the Progressive Signal Tracer and the Progressive Signal Injector, a High Fidelity Guide and a Quiz Book. You receive Membership in Radio-TV Club, Free Consultation Service, Certificate of Merit and Discount Privileges. You receive all parts, tools, instructions, etc. Everything is yours to keep.

Progressive "Edu-Kits" Inc., 1189 Broadway, Dept. 561NN, Hewlett, N. Y. 11557

UNCONDITIONAL MONEY-BACK GUARANTEE

Please rush my Progressive Radio "Edu-Kit" to me, as indicated below: Check one box to indicate choice of model

- Deluxe Model \$31.95.
- New Expanded Model \$34.95 (Same as Deluxe Model plus Television Servicing Course).

Check one box to indicate manner of payment

- I enclose full payment. Ship "Edu-Kit" post paid.
- I enclose \$5 deposit. Ship "Edu-Kit" C.O.D. for balance plus postage.
- Send me FREE additional information describing "Edu-Kit."

Name _____
 Address _____
 City & State _____ Zip _____

PROGRESSIVE "EDU-KITS" INC.

1189 Broadway, Dept. 561NN, Hewlett, N. Y. 11557

Reg. U. S. Pat. Off.



Training Electronics Technicians Since 1946

FREE EXTRAS

• SET OF TOOLS

- SOLDERING IRON
- ELECTRONICS TESTER
- PLIERS-CUTTERS
- VALUABLE DISCOUNT CARD
- CERTIFICATE OF MERIT
- TESTER INSTRUCTION MANUAL
- HIGH FIDELITY GUIDE & QUIZZES
- TELEVISION BOOK
- TROUBLE-SHOOTING BOOK
- MEMBERSHIP IN RADIO-TV CLUB
- CONSULTATION SERVICE
- FCC AMATEUR LICENSE TRAINING
- PRINTED CIRCUITRY

SERVICING LESSONS

You will learn trouble-shooting and servicing in a progressive manner. You will practice with the sets that you construct. You will learn symptoms and causes of trouble in home, portable and car radios. You will learn how to use the professional Signal Tracer, the unique Signal Injector and the dynamic Radio & Electronics Tester. While you are learning in this practical way, you will be able to do many a repair job for your friends and neighbors, and charge fees which will far exceed the price of the "Edu-Kit." Our Consultation Service will help you with any technical problems you may have.

FROM OUR MAIL BAG

J. Stataitis, of 25 Poplar pl., Waterbury, Conn., writes: "I have repaired several sets for my friends, and made money. The "Edu-Kit" paid for itself. I was ready to spend \$240 for a course, but I found your ad and sent for your Kit."

Ben Valerio, P. O. Box 21, Magna, Utah: "The Edu-Kits are wonderful. Here I am sending you the questions and also the answers for them. I have been in Radio for the last seven years, but like to work with Radio Kits, and like to build Radio Testkit Equipment. I enjoyed every minute I worked with the different kits. The Signal Tracer works fine. Also like to let you know that I feel proud of becoming a member of your Radio-TV Club."

Robert L. Shuff, 1534 Monroe Ave., Huntington, W. Va.: "Thought I would drop you a few lines to say that I received my Edu-Kit, and was really amazed that such a bargain can be had at such a low price. I have already started repairing radios and phonographs. My friends were really surprised to see me get into the swing of it so quickly. The Trouble-shooting Tester that comes with the Kit is really good, and finds the trouble, if there is any to be found."

PRINTED CIRCUITRY

At no increase in price, the "Edu-Kit" now includes Printed Circuitry. You build a Printed Circuit Signal Injector, a unique servicing instrument that can detect many Radio and TV troubles. This revolutionary new technique of radio construction is now becoming popular in commercial radio and TV sets.

A Printed Circuit is a special insulated chassis on which has been deposited a conducting material which takes the place of wiring. The various parts are merely plugged in and soldered to terminals.

Printed Circuitry is the basis of modern Automation Electronics. A knowledge of this subject is a necessity today for anyone interested in Electronics.